

MG3710A Vector Signal Generator
MG3740A Analog Signal Generaor
MG3740A-020 Digital Modulation Option

MX370x series software

MX3701xxA IQproducer



MX370x Series Software

The MG3710A Vector Signal Generator supports up to two RF output connectors each with two waveform memories. One RF output connector can output two combined modulation signals, while two connectors can output four modulation signals. As a result, one MG3710A can output wanted + interference signals, wanted + delay signals, and multicarrier signals, which normally requires two vector signal generators, helping cut setup and operation times. The MG3710A has a wide vector modulation bandwidth, large arbitrary waveform memory, and outputs digital modulation signals for major mobile communications technologies. Today's mobile communications are focused mainly on mobile telephones and wireless LAN and the MG3710A offers the ideal signal-generation functions and performance needed for the latest wideband wireless communications. The built-in arbitrary waveform generator outputs modulation signals simply by selecting the waveform pattern matching the required communication method.

The following four categories of waveform patterns are supported:

- Standard waveform patterns
- Waveform patterns generated by optional MX3700xxA Waveform Pattern software
- Waveform patterns generated by optional MX3701xxA IQproducer software
- Waveform patterns converted from data generated by common signal-generation software

Each category contains multiple waveform pattern files each with preset parameters for each system. These default waveform patterns are saved on the MG3710A hard disk for easy access, but other waveform patterns are supported using the IQproducer waveform generation software.

Parameters for the waveform for the target communication system are set using a GUI to a generate a waveform pattern file for the MG3710A. The embedded Windows application IQproducer saves generated arbitrary waveform pattern files to the internal hard disk and signals are output simply by selecting the waveform pattern. In addition, a user-generated custom IQ sample file in ASCII format created by common Electronic Design Automation (EDA) software such as MATLAB, can be converted into a custom waveform pattern file for the MG3710A.

Maximum Waveform Pattern Size and Required Options for Simultaneous Use

• **1stRF (Opt. 032/034/036)**

Combination of Baseband Signal (Opt. 048)	ARB Memory Upgrade 256 Msample (Opt. 045) ARB Memory Upgrade 1024 Msample (Opt. 046)*3		
	W/O	With Opt. 045	With Opt. 046
W/O	64 Msamples x 1 pc	256 Msamples x 1 pc	1024 Msamples x 1 pc*1
With Opt. 048*2	64 Msamples x 2 pcs 128 Msamples x 1 pc	256 Msamples x 2 pcs 512 Msamples x 1 pc	1024 Msamples x 2 pcs*1

• **2ndRF (Opt. 062/064/066)**

Combination of Baseband Signal (Opt. 078)	ARB Memory Upgrade 256 Msample (Opt. 075) ARB Memory Upgrade 1024 Msample (Opt. 076)*3		
	W/O	With Opt. 075	With Opt. 076
W/O	64 Msamples x 1 pc	256 Msamples x 1 pc	1024 Msamples x 1 pc*1
With Opt. 078*2	64 Msamples x 2 pcs 128 Msamples x 1 pc	256 Msamples x 2 pcs 512 Msamples x 1 pc	1024 Msamples x 2 pcs*1

*1: The maximum size per waveform pattern supported by the MG3710A varies with the IQproducer version.

*2: The Baseband Signal Combine option supports two ARB memories and can either set two different waveform patterns or combine them as one memory to support one large waveform pattern.

*3: Does not support MG3740A.

MG3740A with MG3740A-020 Digital Modulation Option supports the following two categories of waveform patterns are supported:

- Waveform patterns generated by optional MX3701xxA IQproducer software
 - MX370102A TDMA IQproducer
 - MX370107A Fading IQproducer
- Waveform patterns converted from data generated by common signal-generation software
- IQproducer Support Systems

Main frame support IQproducer

IQproducer Support Systems		MG3710A	MG3740A Digital Modulation Option (Opt. 020)
Standard Accessories	W-CDMA IQproducer	✓	-
	AWGN IQproducer	✓	-
Option	MX370101A HSDPA/HSUPA IQproducer	✓	-
	MX370102A TDMA IQproducer	✓	✓
	MX370103A CDMA2000 1xEV-DO IQproducer	✓	-
	MX370104A Multi-carrier IQproducer	✓	-
	MX370105A Mobile WiMAX IQproducer	✓	-
	MX370106A DVB-T/H IQproducer	✓	-
	MX370107A Fading IQproducer	✓	✓
	MX370108A LTE IQproducer	✓	-
	MX370108A-001 LTE-Advanced FDD Option	✓	-
	MX370110A LTE TDD IQproducer	✓	-
	MX370110A-001 LTE-Advanced TDD Option	✓	-
	MX370111A WLAN IQproducer	✓	-
	MX370111A-002 802.11ac (160 MHz) Option	✓	-
	MX370112A TD-SCDMA IQproducer	✓	-

● Selection guide

Communication system		Page	LTE (FDD)	LTE-Advanced (FDD)	LTE (TDD)	LTE-Advanced (TDD)	W-CDMA	HSDPA (Test Model5)	HSDPA/HSUPA	1xEV-DO	CDMA2000	GSM/EDGE	TD-SCDMA	Advanced-PHS	PHS	PDC	ETC/DSRC	Digital Broadcast (BS/CS/CATV/SDB-T)	Digital Broadcast (DVB-T/H)	WLAN (IEEE802.11a/b/g)	WLAN (IEEE802.11n/p/a/b/g/l)	WLAN (IEEE802.11ac)	DFS (TELEC, FCC)	DFS (ETSI)	Mobile WiMAX (IEEE802.16e)	Bluetooth	GPS, GLONASS, QZSS	RCR STD-39	ARIB STD-T61/T79/T86	ARIB STD-T98/T102/B54	APCO P25, NXDN, DMR, TETRA				
Waveform pattern*1	Preinstalled		✓		✓		✓	✓	✓	✓	✓	✓	✓	✓	✓	✓	✓	✓	✓	✓	✓	✓	✓	✓	✓	✓	✓	✓	✓	✓	✓	✓			
	MX370073A DFS (TELEC, FCC)																						✓												
IQproducer	MX370075A DFS (ETSI)																							✓											
	Standard accessories AWGN	5																																	
	Standard accessories W-CDMA	7					✓																												
	MX370101A HSDPA/HSUPA	9					✓	✓																											
	MX370102A TDMA	13												✓	✓	✓	✓											✓*5	✓*5	✓*6					
	MX370103A CDMA2000 1xEV-DO	16								✓																									
	MX370104A Multi-carrier	20	Multi-carrier IQproducer is software that generates the multi carrier signal based on waveform pattern of various telecommunications systems.																																
	MX370105A Mobile WiMAX	25																								✓									
	MX370106A DVB-T/H	35																		✓															
	MX370107A Fading	38	Fading IQproducer is software that generates the Fading signal based on waveform pattern of various telecommunication systems.																																
	MX370108A LTE FDD	42	✓																																
	MX370108A-001*2 LTE-Advanced FDD	42		✓																															
	MX370110A LTE TDD	58			✓																														
	MX370110A-001*3 LTE-Advanced TDD	58				✓																													
	MX370111A WLAN	73																				✓													
MX370111A-002*4 802.11ac (160 MHz)	73																					✓													
MX370112A TD-SCDMA	85												✓																						

*1: Read the MX3700xxA Waveform Pattern series catalog.

*2: Requires MX370108A.

*3: Requires MX370110A.

*4: Requires MX370111A.

*5: Sample waveform patterns for each communication system can be downloaded from the Anritsu software download site (requires user and MG3740A product registration).
<<https://my.anritsu.com/home>>

*6: Sample waveform patterns for each communication system can be downloaded from the Anritsu software download site (requires user and MG3710A product registration).
<<https://my.anritsu.com/home>>

● IQproducer Operating Environment

OS	Windows 2000 Professional*1, Windows XP, Windows Vista*2, Windows 7 Enterprise (32-bit)*2, Windows 7 Professional (32-bit/64-bit)*2
CPU	Pentium III 1 GHz equivalent or faster
Memory	512 MB or more
Hard disk space	5 GB or more free space on the drive where this software is to be installed. The free hard disk space necessary to create waveform pattern varies depending on the waveform pattern size. The free disk space of 27 GB or greater is required to create four maximum (512 Msamples) waveform patterns.

*1: Does not support IQproducer Version 13.00 and later

*2: Supports IQproducer Version 12.00 and later

- IQproducer™ is a trademark of Anritsu Corporation.
- MATLAB® is a registered trademark of The MathWorks, Inc.
- CDMA2000® is a registered trademark of the Telecommunications Industry Association (TIA-USA).
- WiMAX® is a trademark or registered trademark of WiMAX Forum.
- The Bluetooth® mark and logos are owned by Bluetooth SIG, Inc. and are used by Anritsu under license.
- Windows® is a registered trademark of Microsoft Corporation in the USA and other countries.
- Pentium® is registered trademarks of Intel Corporation or its subsidiaries in the USA and other countries.
- Other companies, product names and service names are registered trademarks of their respective companies.

MG3710A Vector Signal Generator

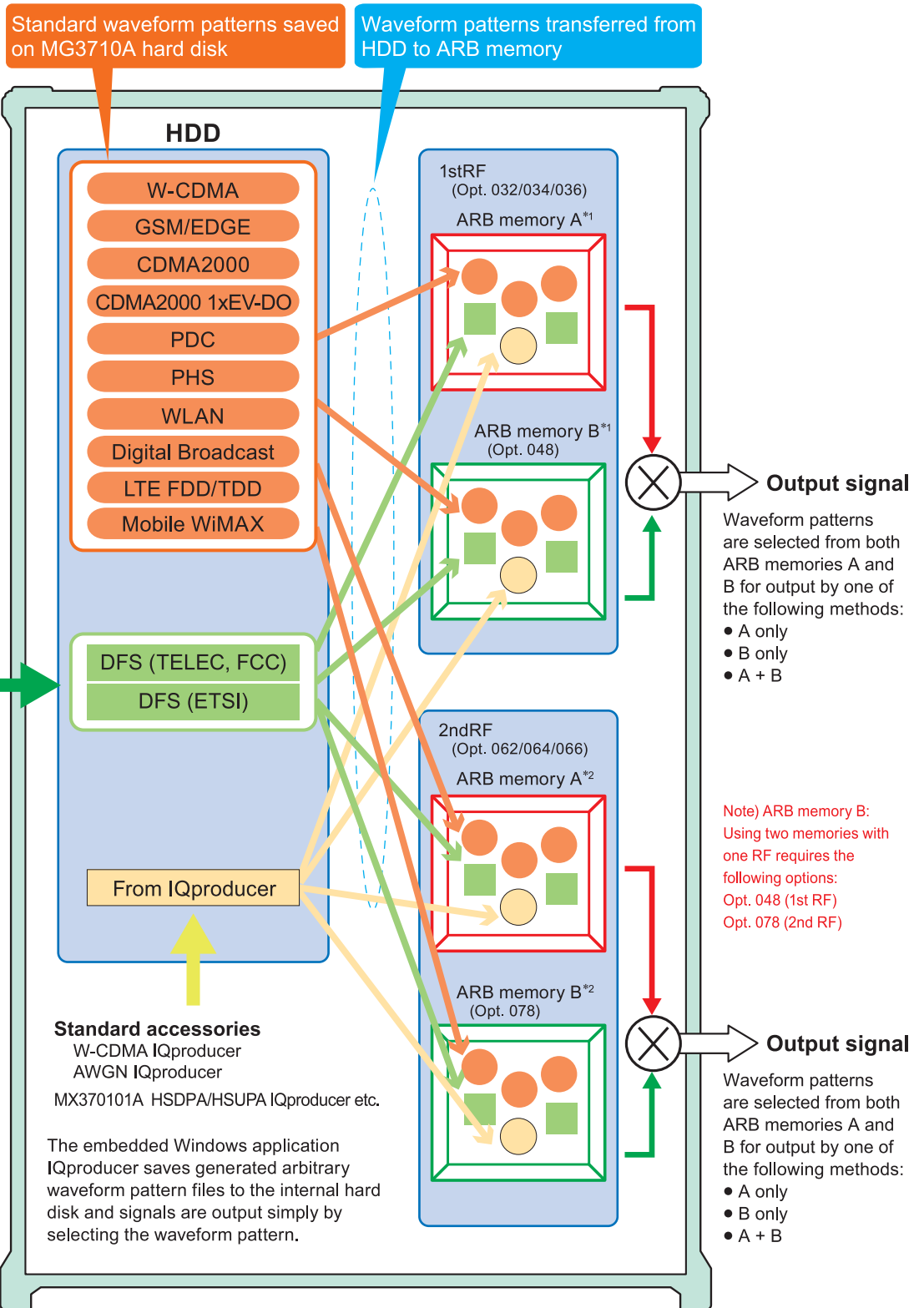

*1: 1stRF ARB memory size
 256 MB x 1 pc = 64 Msamples (Std.)
 1 GB x 1 pc = 256 Msamples x 1 pc (Opt. 045)
 1 GB x 2 pcs = 256 Msamples x 2 pcs (Opt. 045 + Opt. 048)
 4 GB x 1 pc = 1024 Msamples x 1 pc (Opt. 046)
 4 GB x 2 pcs = 1024 Msamples x 2 pcs (Opt. 046 + Opt. 048)

*2: 2ndRF ARB memory size
 256 MB x 1 pc = 64 Msamples (Std.)
 1 GB x 1 pc = 256 Msamples x 1 pc (Opt. 075)
 1 GB x 2 pcs = 256 Msamples x 2 pcs (Opt. 075 + Opt. 078)
 4 GB x 1 pc = 1024 Msamples x 1 pc (Opt. 076)
 4 GB x 2 pcs = 1024 Msamples x 2 pcs (Opt. 076 + Opt. 078)

Additive White Gaussian Noise (AWGN) IQproducer

Standard accessory

MG3710A



This GUI-based application software is used to generate AWGN waveform pattern files optimized for each communication system for the Dynamic Range Test, etc.

The AWGN waveform pattern file is created by setting the same bandwidth and sampling rate as the combined waveform pattern (Wanted Signal) and a multiplier of the Wanted Signal. Specifying the combined waveform pattern (Wanted Signal) from the waveform pattern for the desired communication method automatically sets the Wanted Signal bandwidth and sampling rate. The resultant AWGN waveform pattern and an existing waveform pattern can be combined, which is useful for measuring base-station dynamic range.

<Configurable Parameters>

(With Specified Wanted Signal)

AWGN BW (B)/Wanted Signal BW (A)

(With Unspecified Wanted Signal)

Wanted Signal BW,

AWGN BW (B)/Wanted Signal BW (A)

Sampling Rate

Main Parameter Settings

(1) Wanted Signal BW: Wanted Signal bandwidth
Setting range: 0.0010 MHz to 120.0000 MHz

(2) AWGN BW (B)/Wanted Signal BW (A):
Magnification of AWGN to Wanted Signal
Setting range: 1.0, 1.5, 2.0, 2.5

(3) Sampling Rate
Setting range: 0.0200 MHz to 160.0000 MHz
Becomes same value as Wanted Signal

(4) AWGN BW (B): Bandwidth of AWGN
Calculated automatically from (1) and (2) with following limitation.
Limit range
When $0.020\ 000\ 000\ \text{MHz} \leq \text{Sampling Rate} \leq 20.000\ 000\ 000\ \text{MHz}$:
 $0.001\ 000\ \text{MHz} \leq \text{AWGN BW (B)} \leq \text{Sampling Rate}/2$
When $\text{Sampling Rate} > 20.000\ 000\ 000\ \text{MHz}$:
 $0.001\ 000\ \text{MHz} \leq \text{AWGN BW (B)} \leq \text{Sampling Rate}$

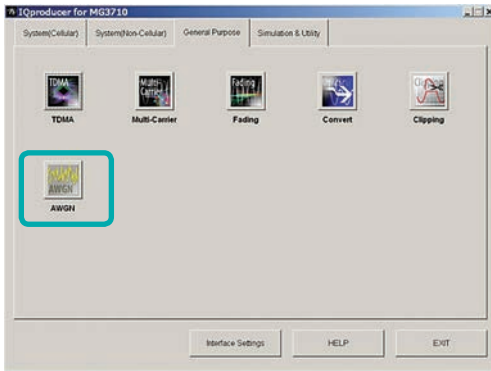

IQproducer Main Screen

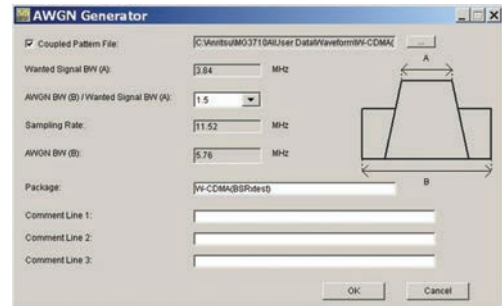

AWGN Setting Screen

AWGN IQproducer

Standard accessory

MG3710A

Adding the Baseband Signal Combine Option (Opt. 048/078) installs two arbitrary waveforms memories for one RF output to set a wanted signal and an interference signal (Figure A).

The two signals are output after combination in the MG3700A internal baseband block.

The signal levels can be set independently and the C/N value can be set too (Fig. B).

In addition, the frequency offset of the Wanted Signal and Interference Signal can be set on-screen (Fig. C).

The built-in Combination function automatically sets the following (Fig. D):

- Set Wanted Signal in Memory A.
- Set Interference Signal in Memory B.
- Set level of Wanted Signal.
- Set Level of Interference Signal.
- Set offset frequency of Wanted Signal and Interfering Signal.

The Combination function* supports full auto-setting of parameters for the Wanted Signal, Interference Signal, Level Ratio, and Frequency Offset simply by selecting the Combination File*. Each parameter can also be set separately on-screen after auto-setting, if necessary.

*: Requires following options:

- MG3710A-048 1stRF Baseband Signal Combine Option (for 1stRF)
- MG3710A-078 2ndRF Baseband Signal Combine Option (for 2ndRF)

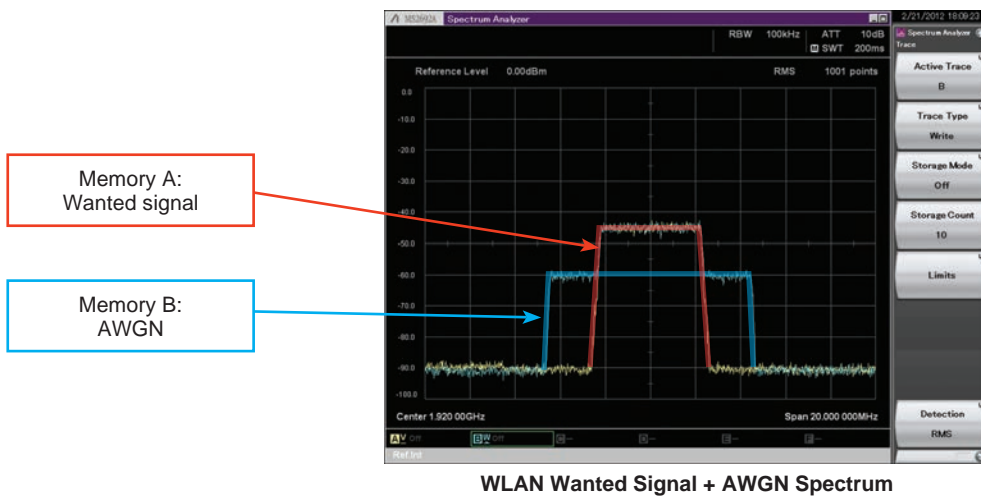
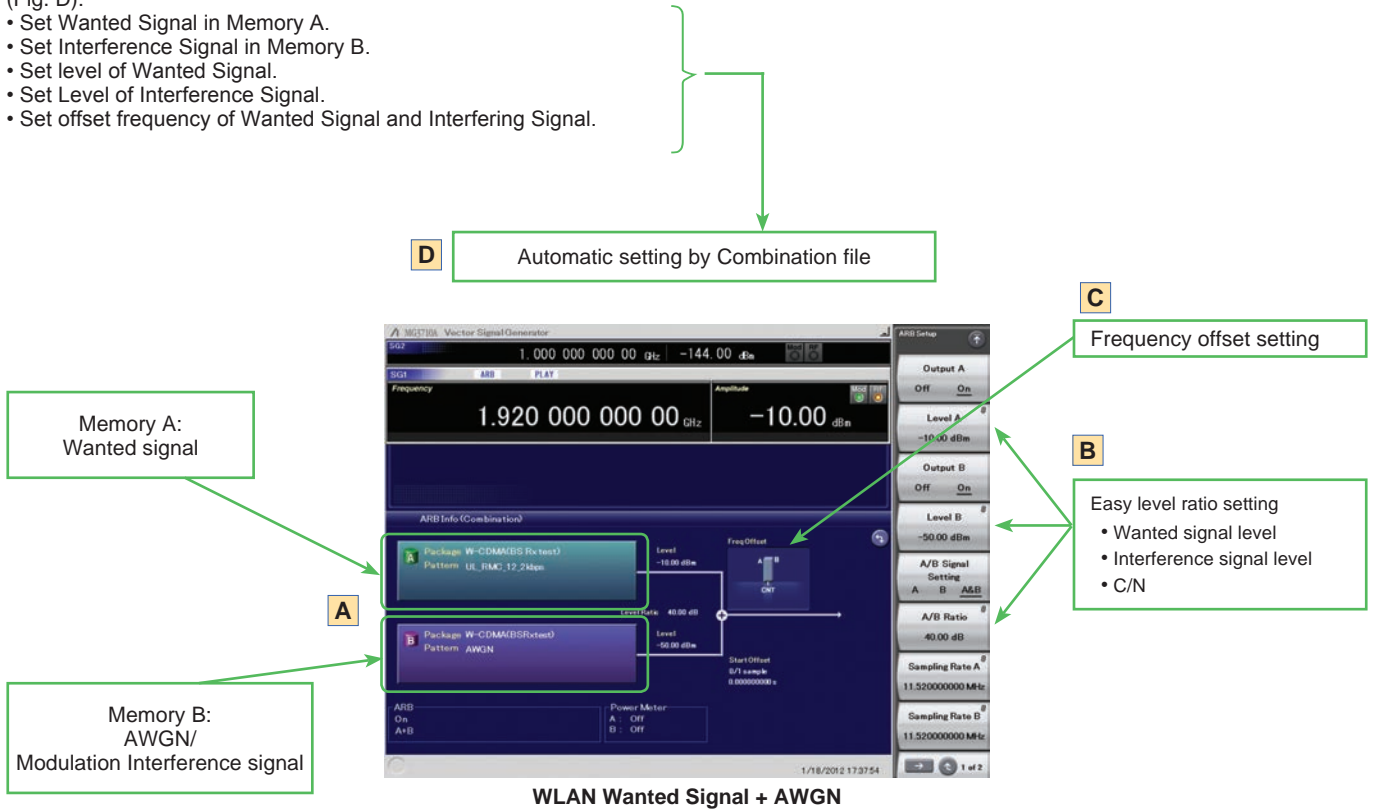

W-CDMA IQproducer

Standard accessory

MG3710A



W-CDMA IQproducer is GUI-based, PC application software for generating waveform patterns used in W-CDMA Rx sensitivity measurement.

It edits the scrambling code number or channelization code number and generates the waveform patterns required for W-CDMA terminal evaluation.

If complete control of all W-CDMA parameters is required, the MX370101A HSDPA/HSUPA IQproducer software (sold separately) can be used. For details, see the MX370101A HSDPA/HSUPA IQproducer section of this document.

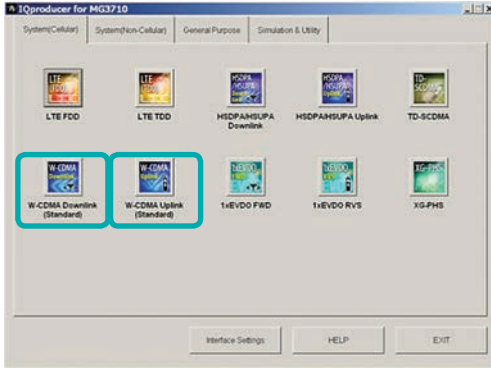

IQproducer Main Screen

• Uplink Settings

Uplink sets parameters including Scrambling code, UL-DPCCH/UL-DPDCH power, DPCH_PhyCH TFCI and Timing Offset, and DPCH_TrCH Data to create the waveform pattern. (For details, see the Uplink Parameter Setting Range table described later.)

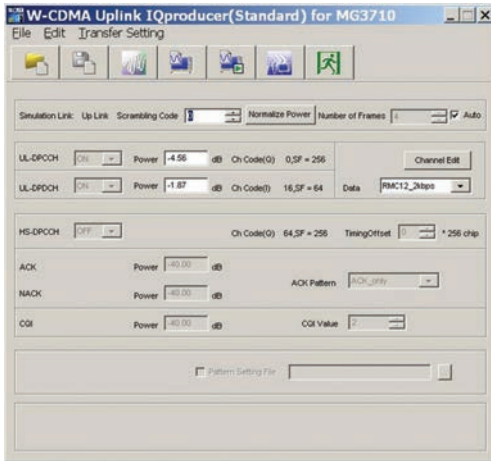

W-CDMA Uplink Setting Screen

• Downlink Settings

Downlink sets parameters including Scrambling code, CPICH/P-CCPCH/PICH/DPCH power, Channelization code, DPCH_PhyCH TFCI and Timing Offset, and DPCH_TrCH Data to create the waveform pattern. (For details, see the Downlink Parameter Setting Range table described later.)

Additionally, the Downlink Easy Setup function supports the Reference Measurement Channel (RMC) items specified by 3GPP TS 25.101 and TS 25.104. Parameter setting is easy just by selecting the items to create the waveform pattern.

Easy Setup Items include:

- RMC: RMC 12.2 kbps (Rx test)
- RMC 12.2 kbps (Performance test)
- RMC 64 kbps (Performance test)
- RMC 144 kbps (Performance test)
- RMC 384 kbps (Performance test)

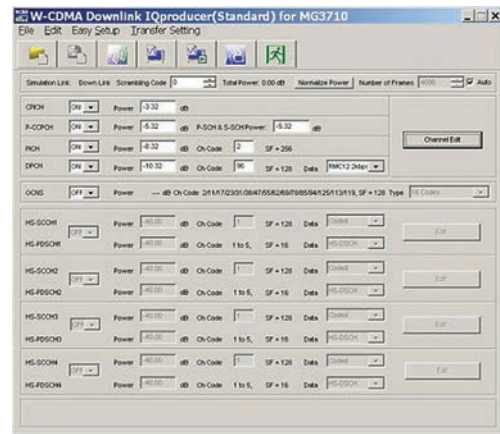

W-CDMA Downlink Setting Screen

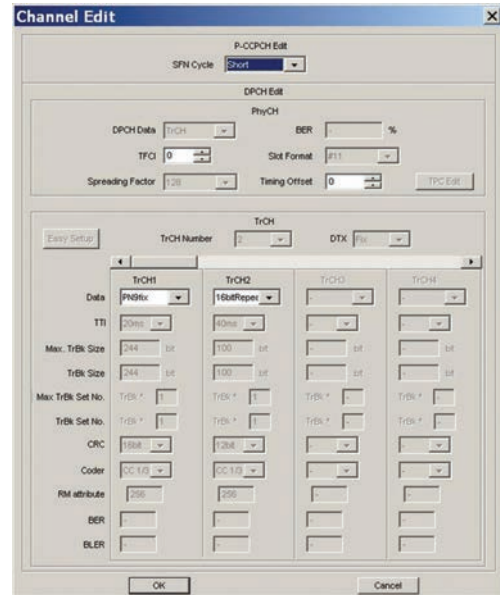

W-CDMA Downlink/Channel Edit Screen

W-CDMA IQproducer

Standard accessory

MG3710A

● Downlink Parameter Setting Range

Display	Setting range	
Scrambling Code		0 to 8191
Number of Frame	Number of Frames	1 to the number of sufficient frames for the waveform memory
	Auto	Selected or cleared the check box
CPICH	ON/OFF	ON or OFF
	Power	-40.00 to 0.00 dB, Resolution 0.01 dB
P-CCPCH	ON/OFF	ON or OFF
	Power	-40.00 to 0.00 dB, Resolution 0.01 dB
	P-SCH & S-SCH Power	-40.00 to 0.00 dB, Resolution 0.01 dB
PICH	ON/OFF	ON or OFF
	Power	-40.00 to 0.00 dB, Resolution 0.01 dB
	Channelization Code	0 to 255
DPCH	ON/OFF	ON or OFF
	Power	-40.00 to 0.00 dB, Resolution 0.01 dB
	Channelization Code	0 to SF -1 The spreading factor (SF) varies with the [Data] setting as follows: RMC 12.2 kbps = 128 RMC 64 kbps = 32 RMC 144 kbps = 16 RMC 384 kbps = 8 AMR1, AMR2, AMR3 = 128 ISDN = 32 384 kbps Packet = 8
	Data	RMC 12.2 kbps, RMC 64 kbps, RMC 144 kbps, RMC 384 kbps, AMR1, AMR2, AMR3, ISDN, 384 kbps Packet
OCNS	ON/OFF	ON or OFF
	Type	16 Codes
P-CCPCH Edit	SFN Cycle	Short or 4096
DPCH Edit (Phy CH)	TFCI	0 to 1023
	Timing Offset	0 to 149
DPCH Edit (TrCH Edit)	Data	PN9, PN9fix, PN15fix, 16bit repeat, User File

● Uplink Parameter Setting Range

Display	Setting range	
Scrambling Code		0 to 16777215
Number of Frame	Number of Frames	1 to the number of sufficient frames for the waveform memory
	Auto	Selected or cleared the check box
UL-DPCCH, UL-DPDCH	Power	-40.00 to 0.00 dB
	Data	RMC 12.2 kbps, RMC 64 kbps, RMC 144 kbps, RMC 384 kbps, AMR1, AMR2, AMR3, ISDN, 64 kbps Packet
DPCH Edit (Phy CH)	TFCI	0 to 1023
	Timing Offset	0 to 149
DPCH Edit (TrCH Edit)	Data	PN9, PN9fix, PN15fix, 16bit repeat, User File
Channel Gain	Beta c	0 to 15
	Beta d	0 to 15

MX370101A HSDPA/HSUPA IQproducer



Optional

MG3710A

This optional GUI-based PC application software is used to set parameters and generate waveform patterns for 3GPP HSDPA/HSUPA (Uplink/Downlink) systems. Using the MG3710A, Vector Signal Generator functionality, the files are loaded, selected, and output as a modulated RF signal. The HS-PDSCH and HS-DPCCH parameters specified in TS 25.212 can be set. The MX370101A supports both downlink and uplink functions.

• Uplink Settings

Uplink sets parameters for UL-DPCCH/UL-DPDCH and HS-DPCCH channels and generates waveform patterns. (For details, see the Uplink Parameter Setting Range table described later).

- HS-DPCCH (ACK, NACK, CQI)
- UL-DPCCH, UL-DPDCH
- E-DPCCH, E-DPDCH (s)

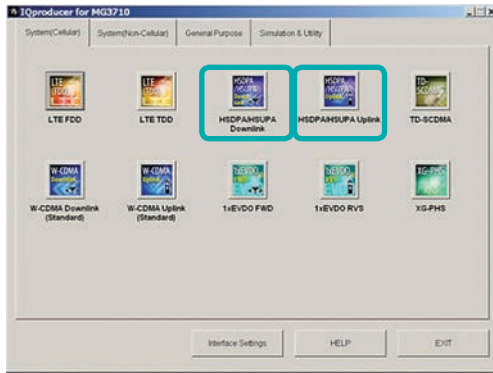

IQproducer Main Screen

• Downlink Settings

Various downlink parameters can be set. (For details, see the Downlink Parameter Setting table described later.) The Downlink Easy Setup function supports the HSDPA Fixed Reference Channel (FRC) items specified in 3GPP TS 25.101, and the Reference Measurement Channel (RMC) items specified in 3GPP TS 25.101 and TS 25.104.

Easy Setup Items include:

- FRC: H-Set1 (QPSK), H-Set1 (16QAM), H-Set2 (QPSK), H-Set2 (16QAM), H-Set3 (QPSK), H-Set3 (16QAM), H-Set4, H-Set5
- RMC: RMC 12.2 kbps (Rx test)
- RMC 12.2 kbps (Performance test)
- RMC 64 kbps (Performance test)
- RMC 144 kbps (Performance test)
- RMC 384 kbps (Performance test)

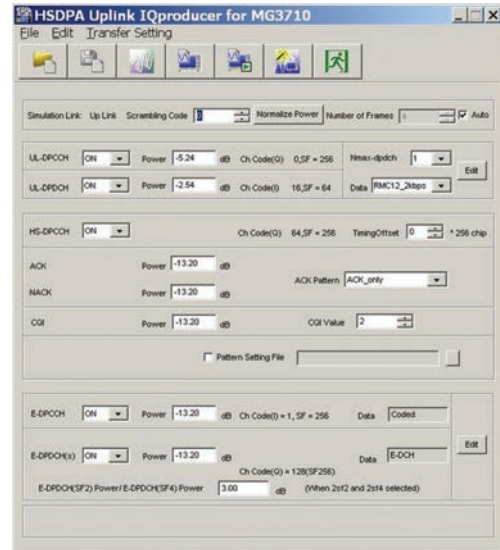

HSDPA Uplink Setting Screen

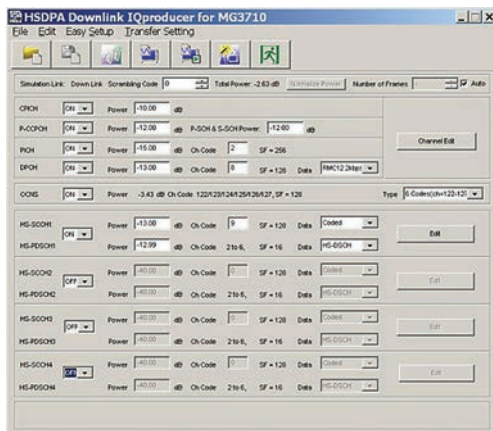

HSDPA Downlink Setting Screen

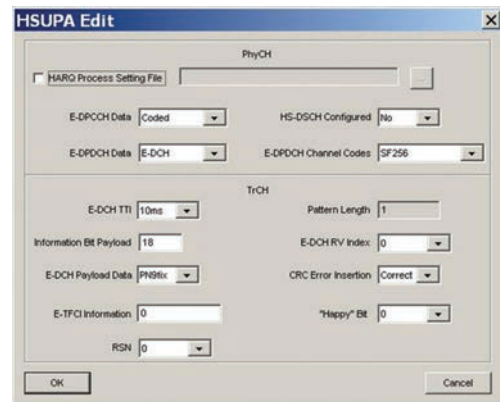

HSDPA Uplink/HSUPA Edit Screen

MX370101A HSDPA/HSUPA IQproducer

Optional

MG3710A

● Downlink Parameter Setting Range

Display	Setting range	
Scrambling Code		0 to 8191
Number of Frames	Number of Frames	1 to the maximum number of frames for the waveform memory
	Auto	Check box selected or cleared
CPICH	ON/OFF	ON or OFF
	Power	-40.00 to 0.00 dB, Resolution 0.01 dB
P-CCPCH	ON/OFF	ON or OFF
	Power	-40.00 to 0.00 dB, Resolution 0.01 dB
	P-SCH & S-SCH Power	-40.00 to 0.00 dB, Resolution 0.01 dB
PICH	ON/OFF	ON or OFF
	Power	-40.00 to 0.00 dB, Resolution 0.01 dB
	Channelization Code	0 to 255
DPCH	ON/OFF	ON or OFF
	Power	-40.00 to 0.00 dB, Resolution 0.01 dB
	Channelization Code	0 to SF - 1 SF (spreading factor) varies depending on the setting of [Data] setting as follows: RMC 12.2 kbps = 128, RMC 64 kbps = 32, RMC 144 kbps = 16, RMC 384 kbps = 8, AMR1, AMR2, AMR3 = 128, ISDN = 32, 384 kbps Packet = 8, User Edit TrCH = Spreading Factor set in the Channel Edit screen
	Data	RMC 12.2 kbps, RMC 64 kbps, RMC 144 kbps, RMC 384 kbps, AMR1, AMR2, AMR3, ISDN, 384 kbps Packet, User Edit TrCH
OCNS	ON/OFF	ON or OFF
	Type	16 Codes, 6 Codes (ch = 122-127), 6 Codes (ch = 2-7)
HS-SCCH1/2/3/4	ON/OFF	ON or OFF
	Power	-40.00 to 0.00 dB, Resolution 0.01 dB
	Channelization Code	0 to 127
	Data	PN9, PN9fix, PN15fix, 16bit repeat, Coded
HS-PDSCH1/2/3/4	ON/OFF	ON or OFF
	Power	-40.00 to 0.00 dB, Resolution 0.01 dB
	Channelization Code	Displays Channelization Code
	Data	PN9, PN9fix, PN15fix, 16bit repeat, HS-DSCH
P-CCPCH Edit	SFN Cycle	Short or 4096
DPCH Edit (Phy CH)	DPCH Data	PN9, PN9fix, PN15fix, 16bit repeat, TrCH
	TFCI	0 to 1023
	Spreading Factor	4, 8, 16, 32, 64, 128, 256, 512
	BER	0.0 to 100.0%, Resolution 0.1%
	Slot Format	#0 to #16
	Timing Offset	0 to 149
	TPC Edit	0000 0000 0000 0000 0000 0000 0000 0000 0000 0000 0000 0000 0000 0000 0000 0000 to 1111 1111 1111 1111 1111 1111 1111 1111 1111 1111 1111 1111 1111 1111 1111 1111
DPCH Edit (TrCH)	TrCH Number	1 to 8
	DTX	Fix, Flex
	Data	PN9, PN9fix, PN15fix, 16bit repeat, User File
	TTI	10, 20, 40, 80 ms
	Max. TrBk Size	0 to 5000
	TrBk Size	0 to 5000
	Max TrBk Set No.	0 to 64
	TrBk Set No.	0 to 64
	CRC	0, 8, 12, 16, 24 bits
	Coder	CC1/2, CC1/3, TC
	RM attribute	1 to 256
	BER	0.0 to 100.0%, Resolution 0.1%
	BLER	0 to 100%, Resolution 1%
HSDPA transport channel (HS-SCCH, HS-PDSCH parameters)	Channelization Code Offset	1 to (16 - Number of Physical Channel Code)
	Number of Physical Channel Code	1 to (16 - Channelization Code Offset)
	Modulation	QPSK or 16QAM
	Transport Block Size Information	0 to 63
	RV Information	0 to 7
	UE Identity	0 to 65535
	CRC Error Insertion	Correct or Fail
	Number of HARQ Processes	0 to 8
	Virtual IR Buffer Size	800 to 304000
	Payload Data	PN9, PN9fix, PN15fix, 16bit repeat
Transmitting Pattern Edit	HARQ Process Cycle	1 to 16 (Note ranges from 1 to 6 when PN9 set for Payload Data)
	Inter-TTI Distance	1 to 8
	TTI Start Offset	0 to 7
	Process Setting File	Use or Not use

● Uplink Parameter Setting Range

Display	Setting range	
Scrambling Code		0 to 16777215
Number of Frames	Number of Frames	1 to the maximum number of frames for the waveform memory
	Auto	Check box selected or cleared
UL-DPCCH, UL-DPDCH	ON/OFF	ON or OFF
	Power	-40.00 to 0.00 dB, Resolution 0.01 dB
	Nmax-dpdch	0, 1
	Data	RMC 12.2 kbps, RMC 64 kbps, RMC 144 kbps, RMC 384 kbps, AMR1, AMR2, AMR3, ISDN, 64 kbps Packet, User Edit TrCH
HS-DPCCH	ON/OFF	ON or OFF
	Timing Offset	0 to 149
	ACK Power	-40.00 to 0.00 dB, Resolution 0.01 dB
	NACK Power	-40.00 to 0.00 dB, Resolution 0.01 dB
	CQI Power	-40.00 to 0.00 dB, Resolution 0.01 dB
	ACK Pattern	ACK_only, NACK_only, alt_ACK_NACK_DTX
	CQI value	0 to 30
E-DPCCH, E-DPDCH	Pattern Setting File	Use or Not use
	E-DPCCH ON/OFF	ON or OFF
	E-DPDCH (s) ON/OFF	ON or OFF
	E-DPCCH Power	-40.00 to 0.00 dB, Resolution 0.01 dB
	E-DPDCH (s) Power	-40.00 to 0.00 dB, Resolution 0.01 dB
E-DPDCH (SF2) Power/ E-DPDCH (SF4) Power		-10.00 to +10.00 dB, Resolution 0.01 dB
DPCH Edit (Phy CH)	UL-DPDCH Data	PN9, PN9fix, PN15fix, 16bit repeat, TrCH
	TFCI	0 to 1023
	UL-DPDCH Spreading Factor	4, 8, 16, 32, 64, 128, 256
	BER	0.0 to 100.0% (Enabled when [Data] set to [PN9]), Resolution 0.1%
	UL-DPDCH Slot Format	#0 or #1
	Timing Offset	0 to 149
DPCH Edit (TrCH)	TPC Edit	0000 0000 0000 0000 0000 0000 0000 0000 0000 0000 0000 0000 0000 0000 0000 0000 to 1111 1111 1111 1111 1111 1111 1111 1111 1111 1111 1111 1111 1111 1111 1111 1111
	TrCH Number	1 to 8
	Data	PN9, PN9fix, PN15fix, 16bit repeat, User File
	TTI	10, 20, 40, 80 ms
	Max. TrBk Size	0 to 5000
	TrBk Size	0 to 5000
	Max TrBk Set No.	0 to 64
	TrBk Set No.	0 to 64
	CRC	0, 8, 12, 16, 24 bits
	Coder	CC1/2, CC1/3, TC
	RM attribute	1 to 256
BER	0.0 to 100.0% (Enabled when [Data] set to [PN9]), Resolution 0.1%	
BLER	0 to 100% (Enabled when [Data] set to [PN9]), Resolution 1%	
E-DPDCH and E-DPCCH Edit (Phy CH)	HARQ Process Setting File	Common dialog opens when the check box is checked. HARQ Process Setting File can be selected.
	E-DPCCH Data	PN9, PN9fix, PN15fix, 16bit repeat, Coded
	E-DPDCH Data	PN9, PN9fix, PN15fix, 16bit repeat, E-DCH
	HS-DSCH Configured	Yes, No
E-DPDCH and E-DPCCH Edit (TrCH)	E-DPDCH Channel Codes	SF256, SF128, SF64, SF32, SF16, SF8, SF4, 2SF4, 2SF2, 2SF2and2SF4 (Note that 2SF2and2SF4 cannot be selected when Nmax-dpdch is set to 1, and SF256 and SF128 cannot be selected when E-DCH TTI is set to 2 ms)
	E-DCH TTI	2 ms, 10 ms
	Pattern Length	Display only ("5" is displayed when E-DCH TTI is set to 2 ms. "1" is displayed when E-DCH TTI is set to 10 ms.)
	Information Bit Payload	18 to 11484 (at E-DCH TTI = 2 ms) 18 to 20000 (at E-DCH TTI = 10 ms)
	E-DCH RV Index	0 to 3
	E-DCH Payload Data	PN9, PN9fix, PN15fix, 16bit repeat
	CRC Error Insertion	Correct, Error
	E-TFCI Information	0 to 127
	"Happy" Bit	0, 1
	RSN	0 to 3

MX370101A HSDPA/HSUPA IQproducer

Optional

MG3710A

Display	Setting range	
HARQ Process Setting File	E-DCH TTI	2 ms, 10 ms
	E-DPDCH ON/OFF	ON, OFF
	HS-DSCH Configured	Yes, No
	HARQ Process 1 Data to HARQ Process 8 Data	PN9, PN9fix, PN15fix, 16bit repeat
	16bit repeat value	0x0000 to 0xFFFF
	HARQ Process 1 RV (Data Retrans) to HARQ Process 8 RV (Data Retrans)	0, 1, 2, 3, 0 (Retrans), 1 (Retrans), 2 (Retrans), 3 (Retrans)
	E-DPDCH (s) Ch Codes	SF256, SF128, SF64, SF32, SF16, SF8, SF4, 2SF4, 2SF2, 2SF2and2SF4 (Note that 2SF2and2SF4 cannot be selected when HS-DSCH Configured is set to Yes, and SF256 and SF128 cannot be selected when E-DCH TTI is set to 2 ms)
	Information Bit Payload	1 to 11484 (when E-DCH TTI = 2 ms) 1 to 20000 (when E-DCH TTI = 10 ms)
	E-DPDCH (s) Gain	-20.00 to 20.00 dB, Resolution 0.01 dB
	SF2 E-DPDCH/SF4 E-DPDCH	-20.00 to 20.00 dB, Resolution 0.01 dB
	CRC Error Insertion	Correct, Error
	E-DPCCH ON/OFF	ON, OFF
	RSN Value	0 to 3
	E-TFCl Info.	0 to 127
	"Happy" Bit	0, 1
	E-DPCCH Gain Factor	-20.00 to 20.00 dB, Resolution 0.01 dB
	Pattern Length	1 to 2048
Channel Gain	DPCCH (Beta c)	0 (Switch Off) to 15 (1.0)
	DPDCH (Beta d)	0 (Switch Off) to 15 (1.0)
	Delta ACK (Beta hs/Beta c)	0 (5/15) to 8 (30/15)
	Delta NACK (Beta hs/Beta c)	0 (5/15) to 8 (30/15)
	Delta CQI (Beta hs/Beta c)	0 (5/15) to 8 (30/15)
	E-DPCCH (Beta ec/Beta c)	0 (5/15) to 8 (30/15)
	E-DPDCH (Beta ed, k/Beta c)	0 (5/15) to 29 (168/15)

MX370102A TDMA IQproducer



Optional

MG3710A

MG3740A

MX370102A TDMA IQproducer is PC application software with a graphical user interface for generating waveform patterns with various digital modulations. Either frame format (burst/continuous) signals or no format signals can be selected.

- Modulation Setting
Sets modulation method, symbol rate and oversample ratio.

Modulation methods:
BPSK, DBPSK, PI/2DBPSK, QPSK, O-QPSK, DQPSK, PI/4DQPSK, 8PSK, D8PSK, 16QAM, 32QAM, 64QAM, 256QAM

Symbol rate: 1 kbps to 80 Mps [MG3710A]
1 kbps to 4 Mps [MG3740A*]
*: Requires MG3740A-020

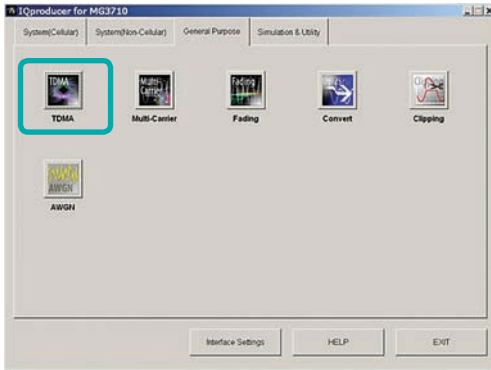

IQproducer Main Screen

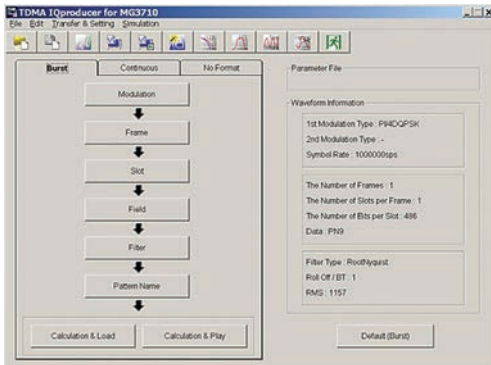

TDMA IQproducer Setting Screen

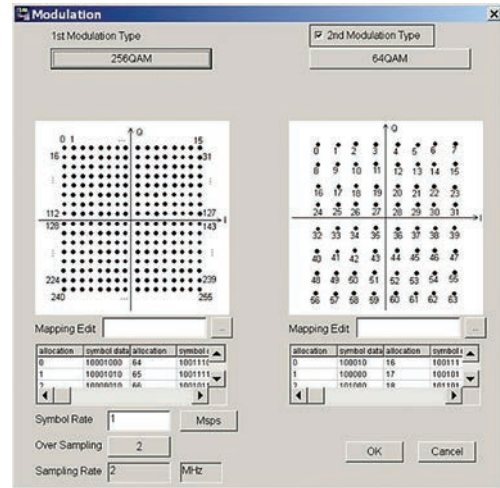

Modulation Screen

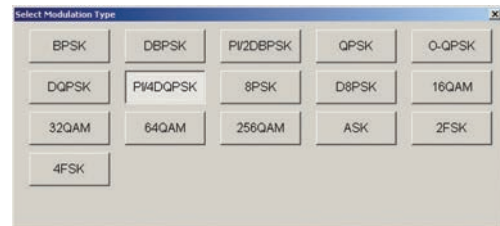

Modulation Type Select Screen

- Parameter Setting Items List

Setting	Parameter Setting Sheet		
	Burst	Continuous	No Format
Modulation	✓	✓	✓
Frame	✓	✓	—
Slot	✓	✓	—
Field	✓	✓	—
Data	—	—	✓
Filter	✓	✓	✓
Pattern Name	✓	✓	✓
Calculation	✓	✓	✓

Burst: Burst signals with slot format
Continuous: Continuous signal with slot format
No Format: Signal without slot format

- Frame Setting
Sets both slot number in one frame and slot Tx mode (On/Off) as well as frame number included in one waveform pattern.

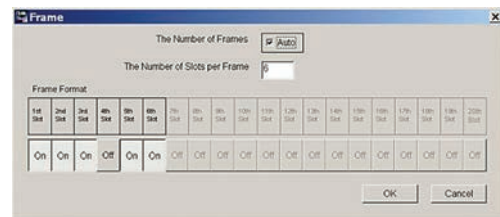

Frame Screen

MX370102A TDMA IQproducer

Optional

MG3710A

MG3740A

- Slot Setting

Sets slot format for communications system as well as synchronization word and data type (PN9, PN15, etc.) placement and bit length.

Targets: Guard, Ramp, Fixed, Data, CRC

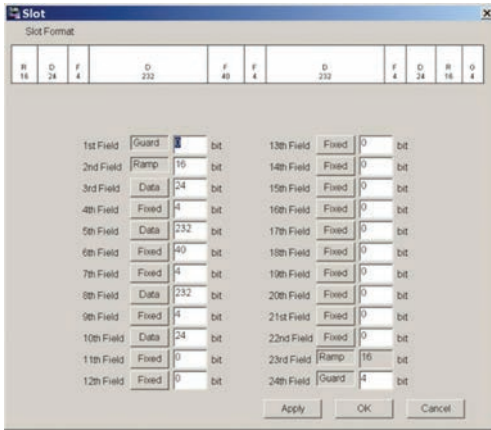

Slot Screen

- Field/Data Setting

Sets bit information set on slot screen and specifies synchronization word and data type.

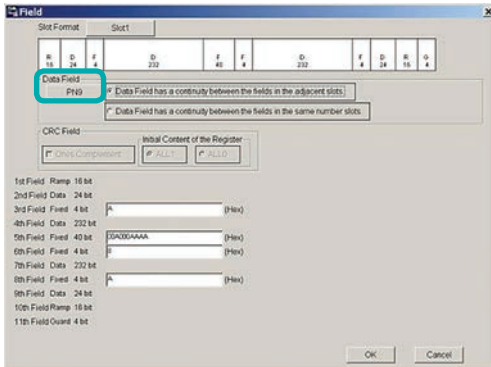

Field Screen



Data Pattern Select Screen

- Filter Setting

Selects filter.

Targets: Nyquist, Root Nyquist, Gaussian, Ideal Lowpass, None, ARIB STD-T98, ARIB STD-T102 Part1, Half-sine

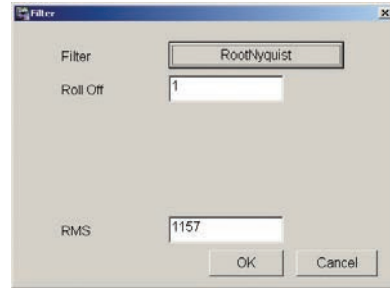

Filter Screen (Root Nyquist)

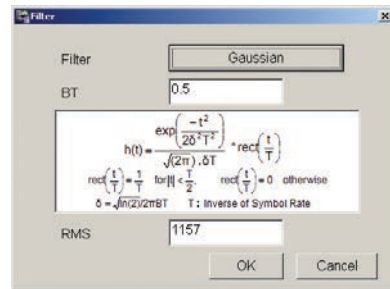

Filter Screen (Gaussian)

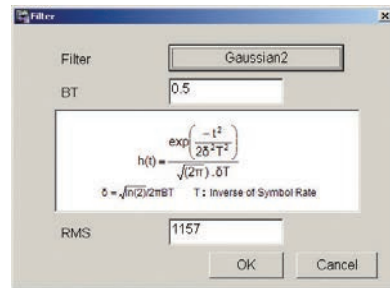

Filter Screen (Gaussian2)

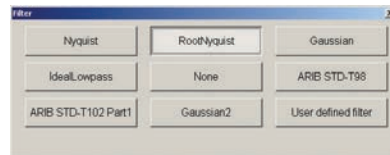

Filter Select Screen (Modulation Method: 4FSK)

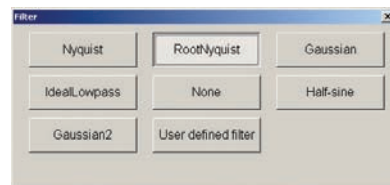

Filter Select Screen (Modulation Method: O-QPSK)

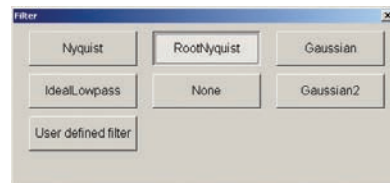

Filter Select Screen (Modulation Method: excluding 4FSK, O-QPSK)

● Parameter Setting Items List

Items	Display	Outline	Setting range
Modulation	Modulation Type (1st Modulation Type)	1st Modulation Type	BPSK, DBPSK, PI/2DBPSK, QPSK, O-QPSK, DQPSK, PI/4DQPSK, 8PSK*1, D8PSK*1, 16QAM*1, 32QAM*1, 64QAM*1, 256QAM*1, ASK, 2FSK, 4FSK*1
	Modulation Type (2nd Modulation Type)	2nd Modulation Type	BPSK, DBPSK, PI/2DBPSK, QPSK, DQPSK, PI/4DQPSK, 8PSK, D8PSK, 16QAM, 32QAM, 64QAM, 256QAM
	Symbol Rate	Symbol Rate	1 kpsps to 80 Msps [MG3710A], 1 kpsps to 4 Msps [MG3740A] (can be set in the 1 sps units)
	Over Sampling	Over Sampling Rate	2, 3, 4, 8, 16, 32
	Sampling Rate	Sampling Rate	20 kHz to 160 MHz [MG3710A], 20 kHz to 8 MHz [MG3740A] (The value of symbol rate x Over sampling rate is set automatically. However, when the Manchester code setting enabled, the value of symbol rate x oversampling rate x 2 is set automatically.)
	GSM	GSM Setting	Enable/disable automatic setting in accordance with GSM (Enabled when 8PSK or 2FSK set as modulation type)
	Modulation Index	Modulation Index	0.00 to 1.00 (for ASK), 0.20 to 10.00 (for 2FSK)
	Manchester Code	Manchester Code	The Manchester code is selected when this checkbox is selected, and NRZ is selected when this checkbox is cleared. NRZ is always selected for modulation types other than ASK.
	Maximum Frequency Deviation	Maximum Frequency Deviation	120 to 2100 (Enabled when 4FSK set as modulation type. Only the multiple of 3 can be set.)
Keep Phase continuity	Keep Phase continuity	This is available when parameter setting sheet is Continuous, No Format, and when modulation method is 2FSK, 4FSK.	
Frame	Number of Frames	Frame number	1 to 32767, Auto
	Number of Slots per Frame	Slot numbers in one frame	1 to 20
Slot (Burst)	1, 24 field	Guard field	Set the number of bits listed in the separate table according to Modulation Type.
	2, 23 field	Ramp field	Set the number of bits listed in the separate table according to Modulation Type.
	3 to 22 field	Fixed (Fixed data) field	The integer from 0 to 128.
	3 to 22 field	Data (PN9, PN15) field	The integer from 0 to 1024.
Slot (Continuous)	4 to 22 field	CRC (Cyclic Redundancy Check character) field	0, 8, 12, 16, 24, 32
	1 to 24 field	Fixed (Fixed data) field	The integer from 0 to 128.
	1 to 24 field	Data (PN9, PN15) field	The integer from 0 to 1024.
Field (Burst/Continuous)	2 to 24 field	CRC (Cyclic Redundancy Check character) field	0, 8, 12, 16, 24, 32
	Slot Format	Select from the list box	
	Fixed	Sets hexadecimal fixed data	0 to maximum value of number of bits set
	CRC	Sets CRC calculation field as integer	1 to number of bits in field on left to CRC (except Guard and Ramp fields)
Data (No Format)	Data Field	Selects continuous pattern	PN9, PN15, 16 bit Pattern, ALL0, ALL1, UserFile*2 Input any hexadecimal number for 16 bit Pattern.
	Data	Selects continuous pattern	PN9, PN15, 16 bit Pattern, ALL0, ALL1, UserFile*2 Input any hexadecimal number for 16 bit Pattern.
Filter	Filter	Filter type	Nyquist, Root Nyquist, Gaussian, Gaussian2, Ideal Lowpass, None, ARIB STD-T98, ARIB STD-T102 Part1, Half-sine, User Defined Filter
	Roll Off/BT	Roll off rate/BT product	0.10 to 1.00 (When Nyquist/Root Nyquist/Gaussian is set.)
	Passband	Passband of filter	Fs/2, Fs/3, Fs/4, Fs/8, Fs/16, Fs/32 (This item is displayed and can be set only when Ideal Lowpass is set as the filter type. The setting range varies with the oversampling rate.)
	RMS	RMS value of waveform pattern	651 to 4104
Pattern Name	Package	Package name	Within 31 characters
	Pattern Name	Waveform pattern file name	Within 20 characters
	Comment	Comment	Within 38 characters
Calculation	Starts waveform pattern data generation after setting parameters.		

*1: Decimal numbers for each symbol point are changed by selecting a user file for IQ mapping.

*2: When "UserFile" is set, the binary sequence is read from a text file. Up to 9,600,000 bits can be loaded and then modulated.

● Guard Field Setting Range

(1st/2nd) Modulation Type	Number of Bits in 1st Field	Number of Bits in 24th Field
BPSK, DBPSK, PI/2DBPSK, ASK, 2FSK	Integer between 0 and 9960	Integer between 0 and 9960
QPSK, DQPSK, PI/4DQPSK, 4FSK	Multiples of 2 between 0 and 9960	Multiples of 2 between 0 and 9960
8PSK, D8PSK	Multiples of 3 between 0 and 9960	Multiples of 3 between 0 and 9960
16QAM	Multiples of 4 between 0 and 9960	Multiples of 4 between 0 and 9960
32QAM	Multiples of 5 between 0 and 9960	Multiples of 5 between 0 and 9960
64QAM	Multiples of 6 between 0 and 9960	Multiples of 6 between 0 and 9960
256QAM	Multiples of 8 between 0 and 9960	Multiples of 8 between 0 and 9960

● Ramp Field Setting Range

(1st/2nd) Modulation Type	Number of Bits
BPSK, DBPSK, PI/2DBPSK, ASK, 2FSK	Integer number between 1 and 16
QPSK, DQPSK, PI/4DQPSK, 4FSK	Multiples of 2 between 2 and 32
8PSK, D8PSK	Multiples of 3 between 3 and 48
16QAM	Multiples of 4 between 4 and 64
32QAM	Multiples of 5 between 5 and 80
64QAM	Multiples of 6 between 6 and 96
256QAM	Multiples of 8 between 8 and 128

MX370103A CDMA2000 1xEV-DO IQproducer



Optional

MG3710A

This optional GUI-based PC application software is used to set parameters and generate waveform pattern files for CDMA2000 1xEV-DO systems (1xEV-DO forward and 1xEV-DO Reverse). The MX370103A supports forward (FWD) and reverse (RVS) link functions.

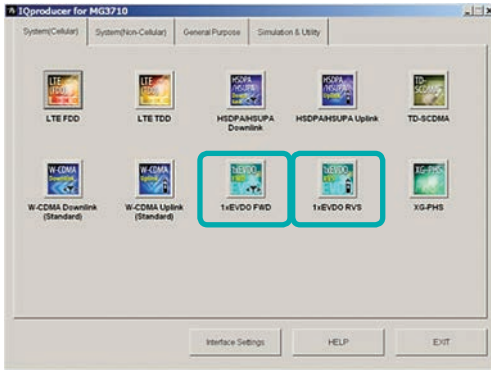

IQproducer Main Screen

- **Forward (FWD) Setting**
Sets single carrier parameter as multi-carrier composition in Carrier Edit sheet of forward link.
The Multicarrier Composition sheet generates a multi-carrier waveform pattern for the single carrier set in Carrier Edit.

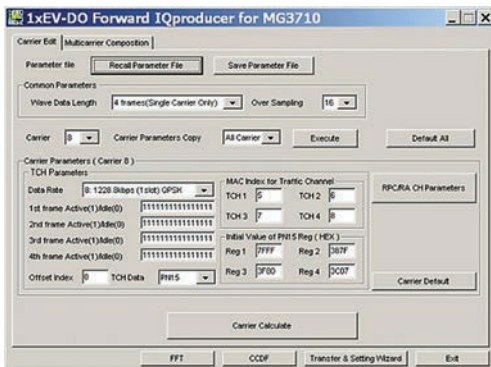

1xEV-DO Forward/Carrier Edit Sheet



1xEV-DO Forward/Multicarrier Composition Sheet

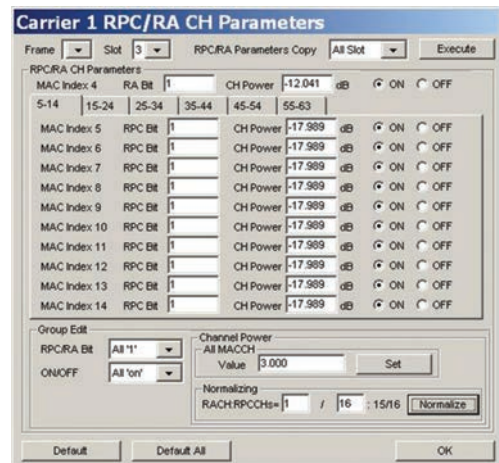

**1xEV-DO Forward/
RPC/RA CH Parameter Sheet**

- **Reverse (RVS) Setting**
Waveform Pattern Edit sheet of reverse link sets parameters for carriers on one screen and generates multi-user signals with freely adjusted frequency, phase, level and delay.
Checks carrier power, frequency offset, delay and phase offset at editing on graph.

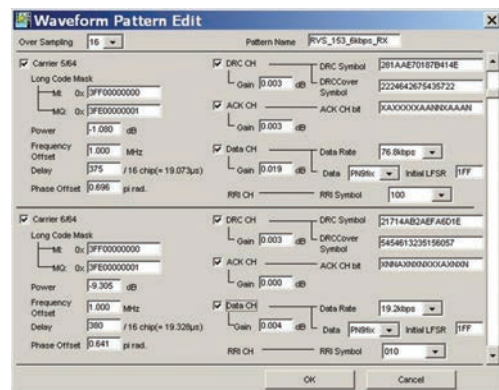

1xEV-DO Reverse/Waveform Pattern Edit Sheet

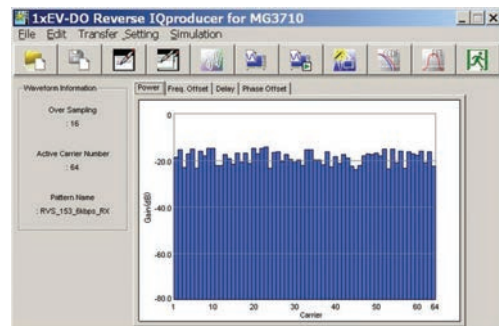

1xEV-DO Reverse/Graph Screen (Power)

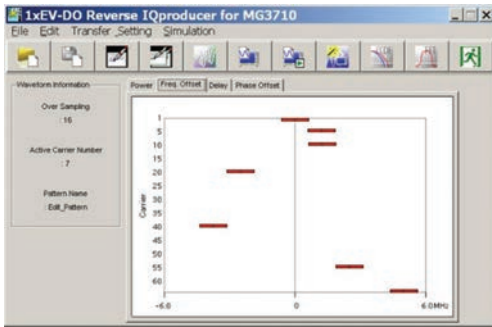

1xEV-DO Reverse/Graph Screen (Freq. Offset)

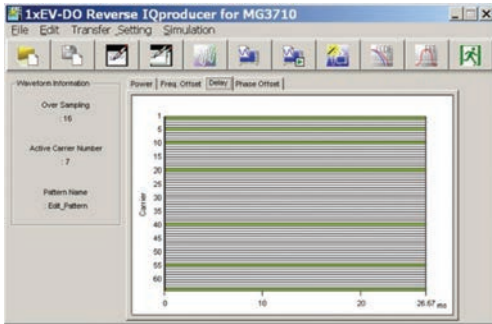

1xEV-DO Reverse/Graph Screen (Delay)

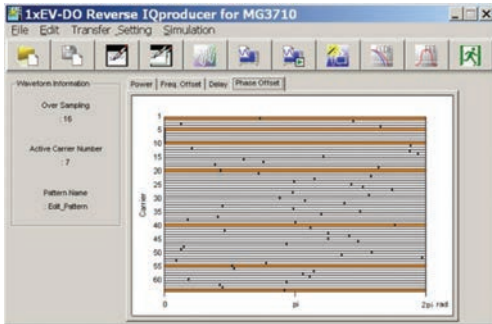

1xEV-DO Reverse/Graph Screen (Phase Offset)

- Reverse (RVS) Quick Edit
Reverse link supports Uniformly Edit sheet and Random Edit sheet as Quick Edit function.
Uniformly Edit sheet specifies multiple carriers and sets multiple parameters to any value at one time.
Random Edit sheet specifies multiple carriers and sets multiple parameters to random values.

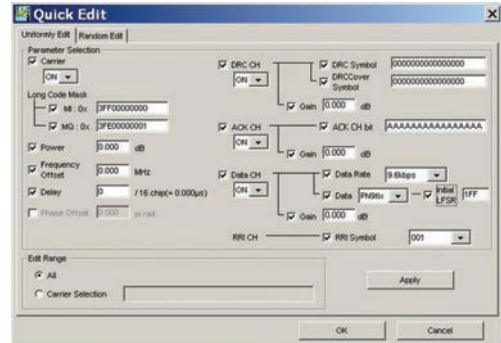

1xEV-DO Reverse/Quick Edit Uniformly Edit Sheet

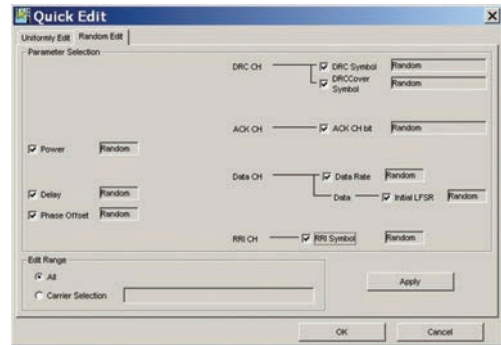

1xEV-DO Reverse/Quick Edit Random Edit Sheet

MX370103A CDMA2000 1xEV-DO IQproducer

Optional

MG3710A

• 1xEV-DO Forward Setting Range

Carrier Edit Sheet

Set the modulation parameters for single carriers (associated with carrier numbers 1 to 9) constituting the multi-carrier on the Carrier Edit sheet.

Display	Setting Range
Wave Data Length	Number of frames of generated waveform pattern. Specify up to 4 frames. Specify 3 frames when generating multi-carrier.
Over Sampling	Over sampling rate for waveform patterns. Set 4, 8, or 16.
Default All	Restores settings of all single carriers to initial values.
Carrier	Select single carrier to be edited from 1 to 9.
Carrier Parameters Copy	Specify single carrier where settings for currently-set single carrier to be copied (copy destination). Set Carrier 1 to Carrier 9 or All Carrier.
Execute	Copies settings of currently-set single carrier (corresponding to carrier number displayed in Carrier) to copy destination specified by Carrier Parameters Copy. Copied settings include contents of RPC/RA CH Parameter screen.
Data Rate	Set data rate and transmission slot for generated single carrier from following: 38.4 kbps (16 slots) QPSK, 76.8 kbps (8 slots) QPSK, 153.6 kbps (4 slots) QPSK, 307.2 kbps (2 slots) QPSK, 614.4 kbps (1 slot) QPSK, 307.2 kbps (4 slots) QPSK, 614.4 kbps (2 slots) QPSK, 1228.8 kbps (1 slot) QPSK, 921.6 kbps (2 slots) 8-PSK, 1843.2 kbps (1 slot) 8-PSK, 1228.8 kbps (2 slots) 16QAM, 2457.6 kbps (1 slot) 16QAM, Idle Slot
1st to 4th Frame Active (1)/Idle (0)	Set traffic channel active/idle for each slot.
TCH Data	Set traffic channel payload data. All '0': Sets payload data to all 0 s. All '1': Sets payload data to all 1 s. PN15: Sets payload data to discontinuous PN15 sequence. PN15 is continuous within a frame.
Offset Index	Specify PN Offset Index of generated single carrier from 0 to 511.
TCH1 to TCH4	Specify MAC Index used for scrambling sequence of traffic channel and preamble Walsh cover as integer from 5 to 63.
Reg1 to Reg4	Initial value of linear feedback shift register used to generate PN15 sequence when TCH Data set to PN15. Set hexadecimal number from 0000 to 7FFF. The offset can be added to the PN15 sequence of each TCH by changing this initial value.
Carrier Default	Restores settings of single carrier currently set on screen to initial values. (The corresponding carrier number is displayed in Carrier.) The settings in the Carrier Parameters frame are restored to the initial values of the single carrier.
RPC/RA CH Parameters	Opens the RPC/RA CH Parameters screen setting parameters of RPC and RA channels.
Carrier Calculate	Generates waveform patterns for 9 single carriers. After clicking this button, the entire process on the Carrier Edit sheet is completed when "Complete" is displayed on the Execution and Result screen.

RPC/RA CH Parameters Sheet

Display	Setting Range
Frame	Selects frame where RPC and RA channels to be edited.
Slot	Selects slot where RPC and RA channels to be edited.
RPC/RA Parameters Copy	The RPC/RA channel parameter settings of the current slot can be copied to other slots. The copy destination slot can be specified here, from Slot 1 to 16, ALL Slot, or All Frame.
RA Bit	RA bit of RA channel. Set 0 or 1.
CH Power	Channel gain of MAC channel (relative value to pilot channel). Set from -40 to +40 dB.
RPC Bit	RPC bit of RPC channel. Set 0 or 1.
ON/OFF	Turns each MAC channel on/off.
RPC/RA Bit (Group Edit)	All the RPC bits in the current slot can be set to 0 or 1.
Channel Power (Group Edit)	The channel gains (value relative to pilot channel) of all the MAC channels in the current slot can be set at once.
ON/OFF (Group Edit)	All the MAC channels in the current slot can be set to ON/OFF at once.
Default	Clicking this button restores the current slot to the initial state.
Default All	Clicking this button restores the RPC/RA CH Parameters settings of the current single carrier to the initial values.
Normalize	Sets all channel gains of RPC and RA channels in currently-set slot collectively to ratio expressed as fraction. The numerator of the RA channel ratio can be set from 1 to denominator -1. The denominator can be set from 2 to 99.

Multi-carrier Composition Sheet

Generates multi-carrier or single carrier waveform pattern from single carrier waveform patterns generated in Carrier Edit sheet

Display	Setting Range
Spacing	Sets frequency interval between carriers with consecutive carrier numbers from 1.20, 1.23, 1.25, or 1.35 MHz.
Carrier Select	Turns on single carrier used to generate multi-carrier (or single carrier, if only one single carrier turned on with all others turned off) in single carrier generated in Carrier Edit sheet.
Target RMS Range	"RMS" indicates the RMS value of the waveform pattern in this event. Max: Indicates the maximum RMS value for waveform pattern RMS adjustment. Min: Indicates the minimum RMS value for waveform pattern RMS adjustment.
RMS Adjustment Value	Sets RMS value of multi-carrier or single-carrier waveform pattern.
RMS Adjust	Converts waveform pattern generated by clicking Composition Execute button into waveform pattern with RMS value close to value input in RMS Adjustment Value.
Pattern Name	The pattern file name can be set within twenty 1-byte characters.

● 1xEV-DO Reverse Setting Range

Display	Description	Setting Range
Over Sampling	Ratio of waveform pattern sampling rate and chip rate.	4, 8, 16
Pattern Name	The waveform pattern file name.	Within 20 characters
Carrier On/Off	Set carrier On/Off. On when checked.	On, Off
Long Code Mask	Set I and Q long code masks. MQ set automatically when MI set by user.	0x0 to 0x3FFFFFFFFF (MI, MQ)
Power	Set carrier power.	-80.000 to 0.000 dB
Frequency Offset	Set carrier frequency offset from center frequency setting of MG3710A.	-5.000 MHz to +5.000 MHz
Delay	Set carrier delay. The delay is the time interval from when a frame trigger is output from the rear panel of the MG3710A to when the first frame of the carrier is output.	0 to 32768 chip
Phase Offset	Set carrier phase offset.	0.000 to 2.000 π rad.
DRC CH On/Off	Set DRC channel On/Off. "On" when checked.	On, Off
DRC CH Gain	Set channel gain of DRC channel by value relative to pilot channel.	-80.000 to +20.000 dB
DRC Symbol	Set DRC channel symbol data in hexadecimal.	0000000000000000 to FFFFFFFFFFFFFF (HEX)
DRC Cover Symbol	Set DRC cover symbol data in octal.	0000000000000000 to 7777777777777777 (OCT)
ACK CH On/Off	Set ACK channel On/Off. "On" when checked.	On, Off
ACK CH Gain	Set channel gain of ACK channel by value relative to pilot channel.	-80.000 to +20.000 dB
ACK CH Bit	Set ACK channel bit.	A (ACK), N (NACK), X (DTX)
Data CH On/Off	Set Data channel On/Off. "On" when checked.	On, Off
Data CH Gain	Set channel gain of Data channel by value relative to pilot channel.	-80.000 to +20.000 dB
Data Rate	Set Data channel data rate.	9.6, 19.2, 38.4, 76.8, 153.6 kbps
Data	Set Data channel payload data. The "PN9fix" selection item specifies a discontinuous PN9 code sequence.	PN9fix, All '0', All '1'
Initial LFSR	When PN9fix set for Data, set initial value of PN9 generation shift register in hexadecimal.	0 to 1FF (HEX)
RRI Symbol Rate	Set RRI symbol in binary.	000 to 101 (BIN)

MX370104A Multi-carrier IQproducer



Optional

MG3710A

MX370104A Multi-carrier IQproducer is PC application software with five functions. It can generate multi-carrier waveform patterns for modulation signals and tone signals for communications systems as well as a combination file using the MG3710A Baseband Signal Combine function (with Opt. 048/078).

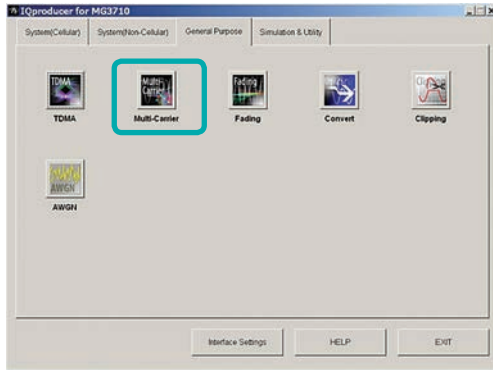

IQproducer Main Screen

● **Multi-purpose Function**

Generates multi-carrier waveform patterns based on waveform patterns and tone signals for MG3710A. It generates signals with up to 32 carriers as one waveform pattern (Depending on the Freq. Offset and waveform pattern combination, sometimes signals for up to 32 carriers cannot be set.) Gain, frequency offset, initial phase and initial delay for carriers can be set too.

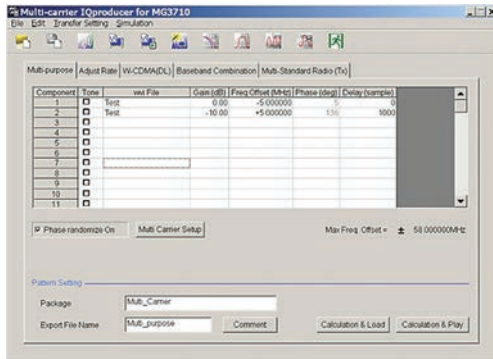

Multi-purpose Function

● **Adjust Rate Function**

The Adjust Rate function converts two waveform patterns with different sampling rates into two waveforms patterns with the same sampling rate.

The initial phase and delay for two carriers can be set. Additionally, the baseband combine function (Opt. 048/078) converts the rates of the waveform pattern rates in memory A and B and combines them to match the sampling rate, helping reduce the Adjust rate setup time.

Note: In some cases, the baseband combine function and adjust rate function cannot combine the sampling rate depending on conditions.

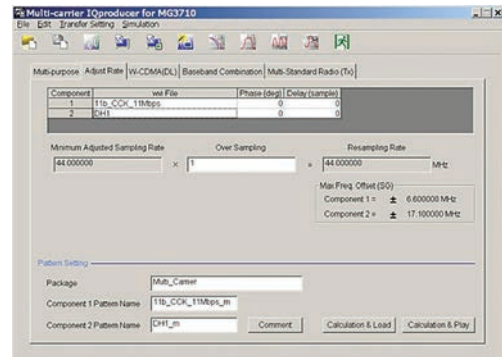

Adjust Rate Function

● **W-CDMA (DL) Function**

This function is used to create a waveform pattern by setting any of the 4 or 5 carriers of the W-CDMA Downlink ON/OFF, as well as by setting the Clipping Method, Clipping Reference Level, and Clipping Ratio.

- Clipping Method
Non, Vector (pre-filter), Vector (post-filter),
Scalar (pre-filter), Scalar (post-filter)
- Clipping Reference level
Peak Power, RMS Power

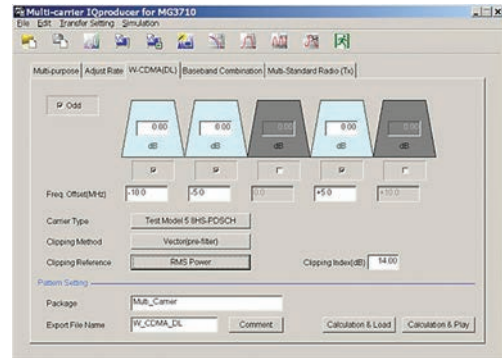

W-CDMA (DL) Function

	Option necessary to use created patterns	
Multi-carrier IQproducer	Combination of Baseband Signal for 1stRF (Opt. 048) Combination of Baseband Signal for 2ndRF (Opt. 078)	AWGN for 1stRF (Opt. 049) AWGN for 2ndRF (Opt. 079)
Multi-purpose	—	—
Adjust Rate	Mandatory	—
W-CDMA (DL)	—	—
Baseband Combination	Mandatory	Mandatory
Multi-Standard Radio (Tx)	Mandatory	—

● Baseband Combination Function

Creates combination file to use with baseband combine function (Opt. 048/078) that outputs two signals, such as wanted + interference signals from one RF port, and sets two waveform patterns, frequency offset and level ratio at the same time. Selecting a previously created combination file supports batch settings. The modulation signal, AWGN, and tone signal can be selected as interference signals. The AWGN option (Opt. 049/079) is required to use AWGN.

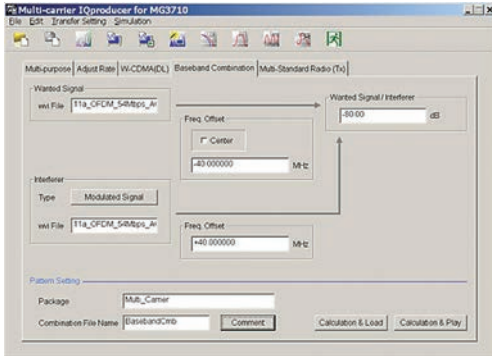

Baseband Combination Function

● Multi-Standard Radio (Tx) Function

Generates W-CDMA•TD-SCDMA•LTE-FDD•LTE-TDD•GSM multi-carrier signals for evaluating Multi-Standard Radio Tx characteristics. Using the baseband combine function (Opt. 048/078) outputs signals simultaneously from one RF connector. However, use the 1stRF and 2ndRF options in combination if the frequency exceeds the RF bandwidth.

• Test Configuration:

- TC1a [UTRA (FDD) multi-carrier]
- TC1b [UTRA (TDD) multi-carrier]
- TC2 [E-UTRA multi-carrier]
- TC3a [UTRA (FDD) + E-UTRA]
- TC3b [UTRA (TDD) + E-UTRA]
- TC4a [UTRA (FDD) + GSM]
- TC4b [E-UTRA + GSM]
- TC4c [UTRA (FDD) + E-UTRA + GSM]

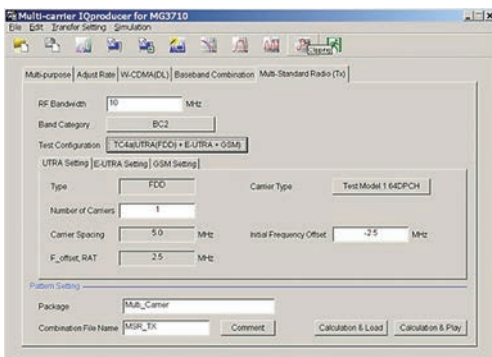

Multi-Standard Radio (Tx) Function UTRA Setting

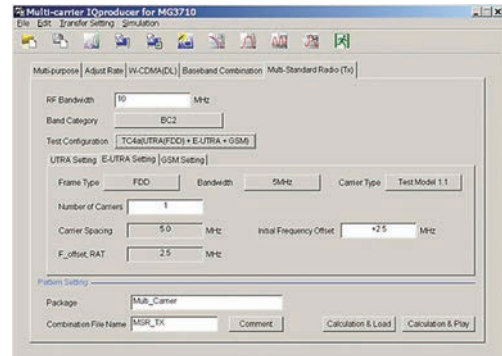

Multi-Standard Radio (Tx) function E-UTRA Setting

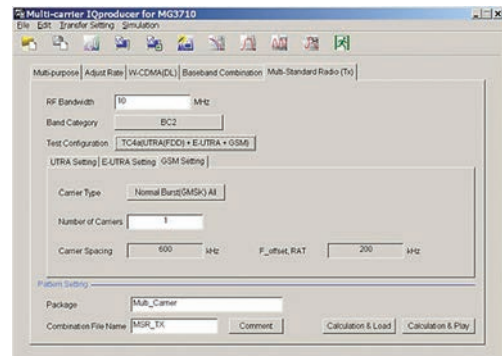

Multi-Standard Radio (Tx) function GSM Setting

Table 1: Test Configuration by Band Category

Test Configuration	Band Category		
	BC1	BC2	BC3
TC1a (UTRA (FDD) multicarrier)	✓	✓	✗
TC1b (UTRA (TDD) multicarrier)	✗	✗	✓
TC2 (E-UTRA multicarrier)	✓	✓	✗
TC3a (UTRA (FDD) + E-UTRA)	✓	✓	✗
TC3b (UTRA (TDD) + E-UTRA)	✗	✗	✓
TC4a (UTRA (FDD) + GSM)	✗	✓	✗
TC4b (E-UTRA + GSM)	✗	✓	✗
TC4c (UTRA (FDD) + E-UTRA + GSM)	✗	✓	✗

Table 2: Display Tab by Test Configuration

Test Configuration	Result Display Type		
	UTRA Setting	E-UTRA Setting	GSM Setting
TC1a (UTRA (FDD) multicarrier)	✓	✗	✗
TC1b (UTRA (TDD) multicarrier)	✓	✗	✗
TC2 (E-UTRA multicarrier)	✗	✓	✗
TC3a (UTRA (FDD) + E-UTRA)	✓	✓	✗
TC3b (UTRA (TDD) + E-UTRA)	✓	✓	✗
TC4a (UTRA (FDD) + GSM)	✓	✗	✓
TC4b (E-UTRA + GSM)	✗	✓	✓
TC4c (UTRA (FDD) + E-UTRA + GSM)	✓	✓	✓

MX370104A Multi-carrier IQproducer

Optional

MG3710A

● Multi-purpose Setting Range

Items	Outline	Setting Range
Multi-purpose		
Tone	Selects whether to use the tone signal or the waveform pattern file for generating multi-carrier signals. When you select Tone, the wvi File text box is disabled, and you cannot select wvi File.	
wvi File	Selects/Deletes the waveform pattern file which will be the source for generating the multi-carrier signal to be set in Component.	
Component		
Gain	Sets the Gain of each Component.	0.00 to -80.00 dB, Resolution 0.01 dB
Freq. Offset	Sets the frequency offset of each Component.	0 to $\pm 0.4 \times F_s - 0.5 \times BW_{max}$ (F_s represents a sampling frequency; BW_{max} represents all band.)
Phase	Sets the initial phase of each Component.	0 to 359 degree, Resolution 1 degree
Delay	Sets the initial delay of each Component.	0 to N-1 (N is the Data Points of the source wvi. file)
Common parameters among tabs		
Phase Randomize On	Randomize the phase of each carrier.	Entering a check enables the function. Then the value of Phase becomes invalid.
Max Freq. Offset	The maximum value of the available frequency offset	Displayed at the right bottom of the screen. You can set the frequency offset of each carrier within the range displayed in this Freq.Offset.
Multi Carrier Setup		
Tone	Sets the Tone signal in the carrier.	When selected: Tone signal, when cleared: wvi File
wvi File	Selects the wvi file to be used as the carrier.	
Carrier Allocation	Sets how to allocate carriers.	<p>Symmetry/Series</p> <p>Initial Frequency Offset</p>
Initial Frequency Offset	Sets the first frequency offset for allocating carriers.	When Tone is selected: 0 to ± 60 MHz, Resolution 1 Hz When Tone is cleared: 0 to $\pm(0.4 \times F_s - 0.5 \times BW)$ MHz (F_s : Sampling rate, BW : Bandwidth value in the wvi. file)
Carrier Spacing	Sets the frequency intervals of the signal to be generated in multi-carrier format.	When Tone is selected: 0.00001 MHz to 120 MHz, Resolution 1 Hz When Tone is cleared: 0 to $\pm(0.4 \times F_s - 0.5 \times BW)$ MHz (F_s : Sampling rate, BW : Bandwidth value in the wvi. file)
Carrier Number	Sets the number of the signals to be generated in multi-carrier format.	1 to 32 (The number of available signals to be set changes depending on the set value of Carrier Spacing.)
Power Step	Sets the level ratio of the signal to be generated in multi-carrier format.	-80.00 to 80.00 dB
Phase Step	Sets the amount of phase change of Component.	0 to 359 degree, Resolution 1 degree
Delay Step	Sets the amount of delay change of Component.	0 to N-1 (where N is Data Points of source wvi. file.)

● Adjust Rate Setting Range

Items	Outline	Setting Range
Adjust Rate		
wvi File	Selects/Deletes the waveform pattern file which will be the source for generating the multi-carrier signal to be set in Component.	
Phase	Sets the initial phase of each Component.	0 to 359 degree, Resolution 1 degree
Delay	Sets the initial delay of each Component.	0 to N-1 (N is the Data Points of the source wvi. file.)
Over Sampling	Sets Over Sampling of the waveform.	1 to floor (160 MHz/Minimum Adjusted Sampling Rate) floor(x) is the function for finding the minimum integer that does not exceed x.

● W-CDMA (DL) Setting Range

Items	Outline	Setting Range
W-CDMA (DL)		
Carrier allocation	Select the carrier allocation	Selected/not selected
Carrier	Select the carrier to be output.	Enabled/disabled
Level	Set the level for each carrier to be output.	0.00 to -80.00 dB, Resolution 0.01 dB
Frequency offset	Set the frequency offset for each carrier to be output.	Frequency offset for each carrier ± 1.0 MHz, Resolution 0.1 MHz
Carrier Type	Select the W-CDMA test model.	Test Model1 16DPCH, Test Model1 32DPCH, Test Model1 64DPCH, Test Model5 2HS-PDSCH, Test Model5 4HS-PDSCH, Test Model5 8HS-PDSCH
Clipping Method	Specify the clipping method.	Non, Vector (pre-filter), Vector (post-filter), Scalar (pre-filter), Scalar (post-filter)
Clipping Reference	Select the reference for clipping processing.	Peak Power, RMS Power
Clipping Index	When Clipping Method is not set to Non, input the ratio to the clipping reference.	When Clipping Reference is set to Peak Power: 0 to 100%, Resolution 1% When Clipping Reference is set to RMS Power, and Clipping Method = Vector (pre-filter), Vector (post-filter): 3.00 to 14.00 dB, Resolution 0.05 dB When Clipping Method = Scalar (pre-filter), Scalar (post-filter): 3.00 to 17.00 dB, Resolution 0.05 dB

● Baseband Combination Setting Range

Items	Outline	Setting Range
Baseband Combination		
wvi File (Wanted Signal)	Selects/Deletes the waveform pattern file to be used as the wanted wave.	
Type (Interferer)	Modulated Signal	Modulated Signal is used as an interference signal.
	AWGN	AWGN is used as an interference signal.
	Tone	Tone is used as an interference waveform.
wvi File (Interferer)	Sets a waveform pattern file to be used as an interference waveform.	When Type is set to a parameter other than Modulated Signal, it is displayed as invalid.
Center Check box (Wanted Signal)	Sets whether or not to set Wanted Signal to the frequency set on the MG3710A.	
Freq Offset text box (Wanted Signal)	Sets the frequency offset of Wanted Signal.	0.000000 to $\pm(0.4 \times F_s - 0.5 \times BW)$ (Fs: Sampling rate, BW: Bandwidth value in the wvi. file)
Freq Offset text box (Interferer)	Sets the frequency offset of Interferer.	0.000000 to $\pm(0.4 \times F_s - 0.5 \times BW)$ (Fs: Sampling rate, BW: Bandwidth value in the wvi. file)
Wanted Signal/Interferer	Sets the level ratio of Wanted Signal and Interferer.	When it is other than Type = AWGN: 0.00 to ± 80.00 dB When Type = AWGN: 0.00 to ± 40.00 dB

● Multi-Standard Radio (Tx) Setting Range

Items	Outline	Setting Range
Multi-Standard Radio (Tx)		
RF Bandwidth	Sets RF Bandwidth.	10 MHz to 120 MHz
Band Category	Set Band Category.	BC1, BC2, BC3
Test Configuration	Set Test Configuration.	<Table 1>
UTRA Setting, E-UTRA Setting, and GSM Setting tabs	The result display type of the tab depends on Test Configuration.	<Table 2>
UTRA Setting tab		
Type	Displays whether the type of the UTRA signal is FDD (W-CDMA) or TDD (TD-SCDMA).	When Band Category = BC1 and BC2: FDD When Band Category = BC3: TDD
Carrier Type	Selects the type of the UTRA signal.	When Type = FDD: Test Model1 16DPCH, Test Model1 32DPCH, Test Model1 64DPCH, Test Model4, Test Model5 2HS-PDSCH, Test Model5 4HS-PDSCH, Test Model5 8HS-PDSCH When Type = TDD: RMC 1Code, RMC 8Code, RMC 10Code
Number of Carriers	Sets the number of UTRA carriers.	The number of carriers not exceeding the bandwidth of 1 to RF Bandwidth
Carrier Spacing	Sets Carrier Spacing.	When Type is FDD: 5 MHz When Type is TDD: 1.6 MHz
Initial Frequency Offset	Sets Initial Frequency Offset.	0.0 to \pm RF Bandwidth/2, Resolution 0.1 MHz
F_offset, RAT	Displays the F_offset, RAT values as specified in TS 37.141.	When Type is FDD: 2.5 MHz When Type is TDD: 1.0 MHz

MX370104A Multi-carrier IQproducer

Optional

MG3710A

Items	Outline	Setting Range																														
E-UTRA tab																																
Frame Type	Selects the Frame type (FDD or TDD) of E-UTRA.	FDD, TDD																														
Bandwidth	Selects Bandwidth of E-UTRA.	1.4, 3, 5, 10, 15, 20 MHz																														
Carrier Type	Selects the type (Test Model) of the E-UTRA signal.	Test Model1.1, Test Model1.2, Test Model2, Test Model3.1, Test Model3.2, Test Model3.3																														
Number of Carriers	Sets the number of E-UTRA carriers.	The number of carriers not exceeding the bandwidth of 1 to RF Bandwidth.																														
Carrier Spacing	Displays Carrier Spacing.																															
Initial Frequency Offset	Sets Initial Frequency Offset.	0.0 to \pm RF Bandwidth/2, Resolution 0.1 MHz																														
F_offset, RAT	Displays the F_offset, RAT values as specified in TS 37.141.	<p>The displayed value depends on the setting of Band Category and Bandwidth.</p> <p style="text-align: center;">F_offset, RAT value</p> <table border="1" style="width: 100%; border-collapse: collapse;"> <thead> <tr> <th rowspan="2">Band Category</th> <th colspan="6">Bandwidth</th> </tr> <tr> <th>1.4 MHz</th> <th>3 MHz</th> <th>5 MHz</th> <th>10 MHz</th> <th>15 MHz</th> <th>20 MHz</th> </tr> </thead> <tbody> <tr> <td>BC1</td> <td>0.9 MHz</td> <td>1.7 MHz</td> <td rowspan="2">2.5 MHz</td> <td rowspan="2">5 MHz</td> <td rowspan="2">7.5 MHz</td> <td rowspan="2">10 MHz</td> </tr> <tr> <td>BC2</td> <td>0.7 MHz</td> <td>1.5 MHz</td> </tr> <tr> <td>BC3</td> <td>0.9 MHz</td> <td>1.7 MHz</td> <td></td> <td></td> <td></td> <td></td> </tr> </tbody> </table>	Band Category	Bandwidth						1.4 MHz	3 MHz	5 MHz	10 MHz	15 MHz	20 MHz	BC1	0.9 MHz	1.7 MHz	2.5 MHz	5 MHz	7.5 MHz	10 MHz	BC2	0.7 MHz	1.5 MHz	BC3	0.9 MHz	1.7 MHz				
Band Category	Bandwidth																															
	1.4 MHz	3 MHz	5 MHz	10 MHz	15 MHz	20 MHz																										
BC1	0.9 MHz	1.7 MHz	2.5 MHz	5 MHz	7.5 MHz	10 MHz																										
BC2	0.7 MHz	1.5 MHz																														
BC3	0.9 MHz	1.7 MHz																														
GSM Setting tab																																
Carrier Type	Selects the type of the GSM signal.	Normal Burst(GMSK) TN0, Normal Burst(GMSK) All, Normal Burst(8PSK) TN0, Normal Burst(8PSK) All																														
Number of Carriers	Sets the number of GSM carriers.	The number of carriers not exceeding the bandwidth of 1 to RF Bandwidth																														
Carrier Spacing	Displays Carrier Spacing.	600 kHz fixed																														
F_offset, RAT	Displays the F_offset, RAT values as specified in TS 37.141.	200 kHz fixed																														

MX370105A Mobile WiMAX IQproducer



Optional **MG3710A**

This GUI-driven PC application software is used to set parameters and generate waveform patterns based on the IEEE 802.16e-2005 WirelessMAN-OFDMA standard. Permutation zones and user bursts are easy to configure in a frame using drop-and-drag functionality in a user-friendly GUI. Modulation, coding type, and coding rate can be set for each user burst. Most receiver tests described in IEEE 802.16e-2005 (Section 8.4.13, Receiver Requirement) can be performed except those functional tests requiring equipment other than a Signal Generator.

- **OFDMA Easy Setup Parameter Function**
Sets number of OFDMA symbol and bandwidth for downlink and uplink to selected values. Values in parentheses on the left show the OFDMA symbol number for downlink and values on the right show the symbol number for uplink. The OFDMA symbol number for downlink and uplink are specified by the Mobile WiMAX System Profile.

BW: 3.5 MHz to 10 MHz

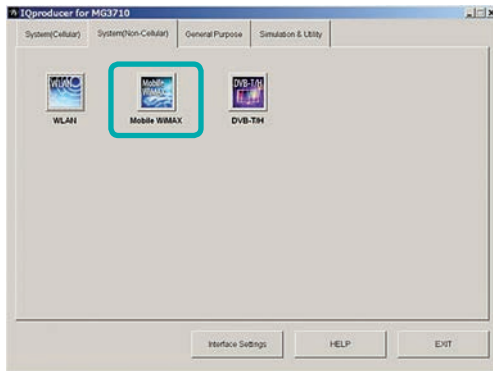

IQproducer Main Screen

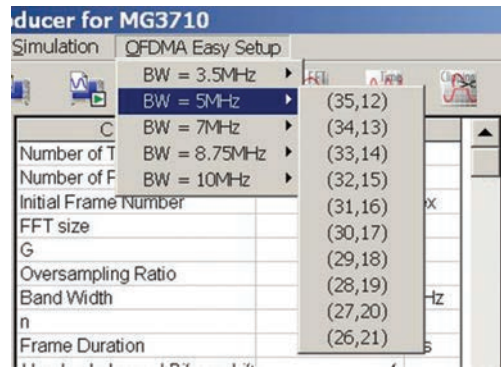

OFDMA Easy Setup Setting Screen

Parameters such as physical layers and filters, are set here.

This tree displays PHY/MAC parameters. The following items can be added and deleted:
DCD, UCD, Downlink, Uplink, Preamble, FCH, MAC Message, Zone, Burst, MAC PDU, DL-MAP, UL-MAP

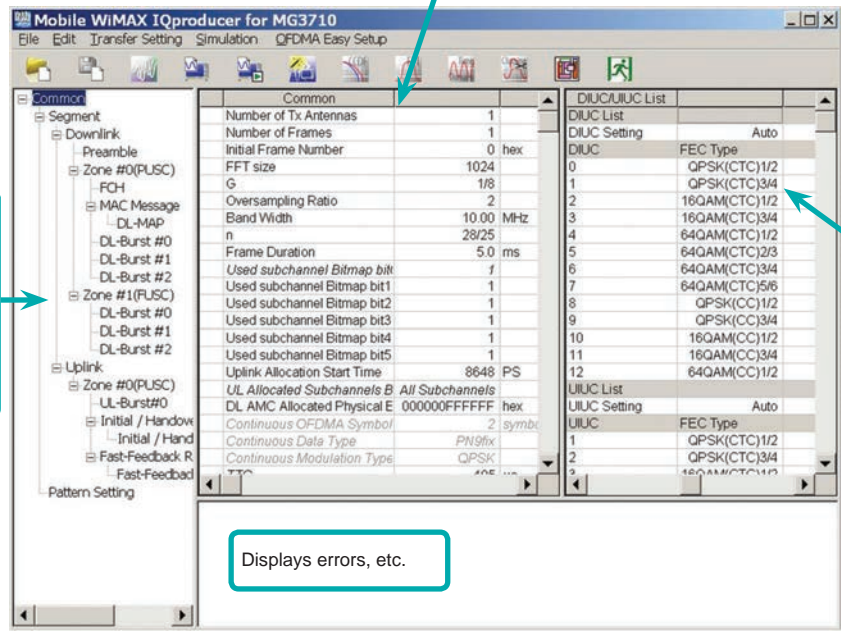

Parameters for items selected in the tree on the left and at the Segment Edit screen are set here.

Displays errors, etc.

Mobile WiMAX IQproducer Setting Screen

MX370105A Mobile WiMAX IQproducer

Optional

MG3710A

Excellent Operability: Segment Edit Screen

- The magnified or reduced Zone or Burst can be edited drop-and-drag techniques.
- The editing result is reflected in the Main screen parameters.
- An information window opens to describe parameters of any selected area.
- Parameters for the selected area are displayed on the Main screen.

This button displays the Segment Edit screen for checking and editing the Segment MAP.

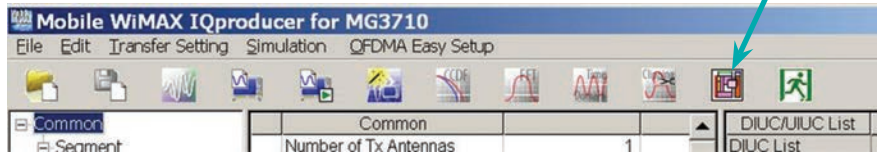

Mobile WiMAX IQproducer Setting Screen

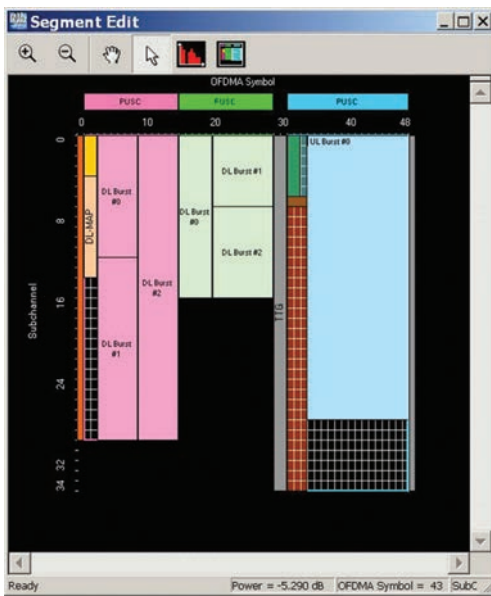

Parameters for the clicked zone are displayed at the Main Screen.

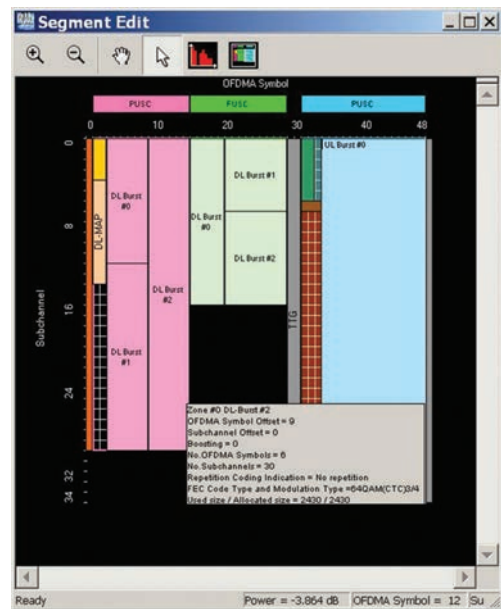

Segment Edit Screen

• STC/MIMO Setting

Setting two Tx Antennas at the Common parameter settings sets STC/MIMO (Matrix A/B) as the downlink signal Zone or Burst units.

Number of Antennas

Common	
Number of Tx Antennas	1
Number of Frames	1
Initial Frame Number	2 hex
FFT size	1024
G	1/8

STC/MIMO

Zone #1	
Data Status	Enable
Permutation	PUSC
Pilot Position	Hopping
Dedicated Pilot	0
Pilot Boosting	OFF
STC/MIMO	No transmit diversity
OFDMA Symbol Offset	No transmit diversity
No. OFDMA Symbols	2 antenna matrixA(STTD)
DL-PermBase	2 antenna matrixB vertical encoding

Matrix Indicator

DL-Burst #0	
Data Status	Enable
OFDMA Symbol Offset	15
OFDMA Subchannel Offset	0
Boosting	0 dB
No. OFDMA Symbols	6
No. Subchannels	16
Repetition Coding Indication	No repetition
FEC Code Type and Modulation Type	QPSK(CTC)3/4
Inclusion MAP	Normal
DL-Burst Data Type	PN9fix
Matrix Indicator	matrix A

● Parameter Setting Items

Tree	Items	Setting Range	Frame Duration = Continuous	
Common	Number of Tx Antennas	1, 2		
	Number of Frames	1 to Maximum number of Frame saved in memory	Can not be set.	
	Initial Frame Number	0x000000 to 0xFFFFFFFF	Can not be set.	
	FFT size	128, 512, 1024, 2048		
	G	1/4, 1/8, 1/16, 1/32		
	Oversampling Ratio	2, 4, 8		
	Bandwidth	1.25, 1.50, 1.75, 2.50, 3.00, 3.50, 5.00, 6.00, 7.00, 8.75, 10.00, 12.00, 14.00, 15.00, 17.50, 20.00, 24.00, 28.00 MHz		
	n	8/7, 28/25		
	Frame Duration	2.0, 2.5, 4.0, 5.0, 8.0, 10.0, 12.5, 20.0 ms, Continuous		
	Used subchannel Bitmap bit0 to bit5	1, 0 This parameter is applied to all the Downlink PUSC zones, except for PUSC (all SC). When Segment Index = 0, bit0 = 1; when Segment Index = 1, bit 2 = 1, when Segment Index = 2, bit 4 = 1.		
	Uplink Allocated Start Time	0 to Frame End PS	Can not be set.	
	UL Allocated Subchannels Bitmap	All Subchannels		
	DL AMC Allocated Physical Bands Bitmap	FFT Size = 2048: 000000000000 to FFFFFFFF FFT Size = 1024: 000000000000 to 000000FFFFFF FFT Size = 512: 000000000000 to 00000000FFFF FFT Size = 128: 000000000000 to 000000000007		
	Continuous OFDMA Symbols	2 to maximum number of OFDMA Symbol in memory (2 symbol step):	Can be set	
	Continuous Data Type	16bit repeat, PN9fix, PN15fix, S_QPSK, S_16QAM, S_64QAM, User File Coding, and Randomization cannot be set at data selected here.	Can be set	
	Continuous Data Type Repeat Data	0x0000 to 0xFFFF: Display when Continuous Data Type = 16bit repeat	Can be set	
	Continuous Data Type User File	User File selected: Display when Continuous Data Type = User File	Can be set	
	Continuous Modulation Type	QPSK, 16QAM, 64QAM	Can be set	
	TTG	Display only: Gap interval between Downlink and Uplink displayed		
	RTG	Display only: Gap interval between Uplink and Frame End displayed		
	Subcarrier Spacing	Display only		
	Sampling Frequency	Display only: Depends on bandwidth, n (Sampling Factor), and Oversampling Ratio		
	Segment Index	0, 1, 2	Can not be set.	
	Preamble Index	<Table 1>	Can not be set.	
	Roll off length	0 to 32		
	Filter			
	Filter Type	Non, Gaussian, Root Nyquist, Nyquist, Ideal		
	Roll Off/BT	0.1 to 1.0 (Cannot be set when Filter Type = Non, Ideal)		
	Filter Length	1 to 1024 (Cannot be set when Filter Type = Non, Ideal)		
	DLFP			
	Repetition Coding Indication	No repetition, 2, 4, 6	Can not be set.	
	Coding Indication	CC, CTC	Can not be set.	
	DIUC Setting	Auto, Manual		
DIUC List	QPSK (CC) 1/2, QPSK (CC) 3/4, 16QAM (CC) 1/2, 16QAM (CC) 3/4, 64QAM (CC) 1/2, 64QAM (CC) 2/3, 64QAM (CC) 3/4, QPSK (CTC) 1/2, QPSK (CTC) 3/4, 16QAM (CTC) 1/2, 16QAM (CTC) 3/4, 64QAM (CTC) 1/2, 64QAM (CTC) 2/3, 64QAM (CTC) 3/4, 64QAM (CTC) 5/6			
UIUC Setting	Auto, Manual			
UIUC List	QPSK (CC) 1/2, QPSK (CC) 3/4, 16QAM (CC) 1/2, 16QAM (CC) 3/4, 64QAM (CC) 1/2, 64QAM (CC) 2/3, 64QAM (CC) 3/4, QPSK (CTC) 1/2, QPSK (CTC) 3/4, 16QAM (CTC) 1/2, 16QAM (CTC) 3/4, 64QAM (CTC) 1/2, 64QAM (CTC) 2/3, 64QAM (CTC) 3/4, 64QAM (CTC) 5/6			
Segment	Multi-Path Setting	Enable, Disable		
	Tx Antenna0, 1	Multi-path Number: 1 to 20 Delay: 0.0 to 10000.0 ns Gain: -80.0 to 0.0 dB Phase: 0.0 to 359.9 deg.		

Table 1: Preamble Index Setting Range

When Segment Index=0	When Segment Index=1	When Segment Index=2
0(IDcell=0), 1(IDcell=1), 2(IDcell=2), 3(IDcell=3), 4(IDcell=4), 5(IDcell=5), 6(IDcell=6), 7(IDcell=7), 8(IDcell=8), 9(IDcell=9), 10(IDcell=10), 11(IDcell=11), 12(IDcell=12), 13(IDcell=13), 14(IDcell=14), 15(IDcell=15), 16(IDcell=16), 17(IDcell=17), 18(IDcell=18), 19(IDcell=19), 20(IDcell=20), 21(IDcell=21), 22(IDcell=22), 23(IDcell=23), 24(IDcell=24), 25(IDcell=25), 26(IDcell=26), 27(IDcell=27), 28(IDcell=28), 29(IDcell=29), 30(IDcell=30), 31(IDcell=31), 96(IDcell=0), 99(IDcell=3), 102(IDcell=6), 105(IDcell=9), 108(IDcell=12), 111(IDcell=15)	32(IDcell=0), 33(IDcell=1), 34(IDcell=2), 35(IDcell=3), 36(IDcell=4), 37(IDcell=5), 38(IDcell=6), 39(IDcell=7), 40(IDcell=8), 41(IDcell=9), 42(IDcell=10), 43(IDcell=11), 44(IDcell=12), 45(IDcell=13), 46(IDcell=14), 47(IDcell=15), 48(IDcell=16), 49(IDcell=17), 50(IDcell=18), 51(IDcell=19), 52(IDcell=20), 53(IDcell=21), 54(IDcell=22), 55(IDcell=23), 56(IDcell=24), 57(IDcell=25), 58(IDcell=26), 59(IDcell=27), 60(IDcell=28), 61(IDcell=29), 62(IDcell=30), 63(IDcell=31), 97(IDcell=1), 100(IDcell=4), 103(IDcell=7), 106(IDcell=10), 109(IDcell=13), 112(IDcell=16)	64(IDcell=0), 65(IDcell=1), 66(IDcell=2), 67(IDcell=3), 68(IDcell=4), 69(IDcell=5), 70(IDcell=6), 71(IDcell=7), 72(IDcell=8), 73(IDcell=9), 74(IDcell=10), 75(IDcell=11), 76(IDcell=12), 77(IDcell=13), 78(IDcell=14), 79(IDcell=15), 80(IDcell=16), 81(IDcell=17), 82(IDcell=18), 83(IDcell=19), 84(IDcell=20), 85(IDcell=21), 86(IDcell=22), 87(IDcell=23), 88(IDcell=24), 89(IDcell=25), 90(IDcell=26), 91(IDcell=27), 92(IDcell=28), 93(IDcell=29), 94(IDcell=30), 95(IDcell=31), 98(IDcell=2), 101(IDcell=5), 104(IDcell=8), 107(IDcell=11), 110(IDcell=14), 113(IDcell=17)

MX370105A Mobile WiMAX IQproducer

Optional

MG3710A

● PHY/MAC Parameter (Downlink) Setting Range

Tree	Items	Setting Range
Downlink	Data Status	Enable, Disable
Preamble	Data Status	Enable, Disable
	Preamble Index	Display only: Set at Common.
	IDcell	Display only: Depends on Preamble Index setting
Zone#0 to #7	Data Status	Enable, Disable
	Permutation	PUSC, PUSC (all SC), FUSC, AMC (6x1), AMC (3x2), AMC (2x3), AMC (1x6)
	Pilot Position	Hopping, Center
	Dedicated Pilot	0, 1
	Pilot Boosting	OFF, ON
	STC/MIMO	No transmit diversity, 2 Antenna Matrix A (STTD), 2 Antenna Matrix B vertical encoding
	OFDMA Symbol Offset	Zone#0: Display only Zone#1 to #7: 0 to 255 symbol (without Preamble), 1 to 255 symbol (with Preamble)
	No. OFDMA Symbols	2 to 254 symbol (when PUSC), 2 to 254 symbol (when PUSC (all SC)), 1 to 255 symbol (when FUSC), 1 to 255 symbol (when AMC (6x1)), 2 to 254 symbol (when AMC (3x2)), 3 to 255 symbol (when AMC (2x3)), 6 to 252 symbol (when AMC (1x6))
	DL-PermBase	0 to 31 (Cannot be set at Zone#0)
	DL-Burst Number	1 to 16
	PRBS_ID	0 to 3 (Cannot be set at Zone#0)
FCH	Data Status	Enable, Disable
	FCH Type	16bit repeat, PN9fix, PN15fix, DLFP, User File
	FCH Type Repeat Data	0x0000 to 0xFFFF: Display when FCH Type = 16bit repeat
	FCH Type User File	User File selected: Display when FCH Type = User File
	Used subchannel Bitmap bit0 to 5	Display only: Set at Common
	Repetition Coding Indication	Display only: Set at Common
	Coding Indication	Display only: Set at Common
	DL-MAP Length	Display only: Set at DL-MAP
	DL-MAP Length	Display only: Set at DL-MAP
MAC Message	Data Status	Enable, Disable
DL-MAP	Data Status	Enable, Disable
	DL-MAP Type	16bit repeat, PN9fix, PN15fix, S_QPSK, S_16QAM, S_64QAM, DL-MAP, Compressed DL-MAP, User File
	DL-MAP Type Repeat Data	0x0000 to 0xFFFF: Display when DL-MAP Type = 16bit repeat
	DL-MAP Type User File	User File selected: Display when DL-MAP Type = User File
	DL-MAP Length	0 to 255 slot (The calculation value is displayed when DL-MAP Type = DL-MAP or Compressed DL-MAP. The data length of DL-MAP can be set in other cases.)
	DCD Count	0 to 255: Can be set when DL-MAP Type = DL-MAP or Compressed DL-MAP
	Base Station ID	0x0000 0000 0000 to 0xFFFF FFFF FFFF: Can be set when DL-MAP Type = DL-MAP or Compressed DL-MAP
	DL-MAP PHY Synchronization Field	
	Frame Duration	Display only: Set at Common
	Initial Frame Number	Display only: Set at Common
	DL-MAP IE	
	DIUC	0 to 12 (Cannot be set when DIUC Setting = Auto)
	OFDMA Symbol Offset	Display only: Set at DL-Burst
	OFDMA Subchannel Offset	Display only: Set at DL-Burst
	Boosting	Display only: Set at DL-Burst
	No. OFDMA Symbols	Display only: Set at DL-Burst
	No. Subchannels	Display only: Set at DL-Burst
	Repetition Coding Indication	Display only: Set at DL-Burst
	STC/Zone switch IE	
	OFDMA Symbol Offset	Display only
	Permutation	Display only: Set at DL-Zone.
	DL Use All SC Indicator	Display only
	DL-PermBase	Display only: Set at DL-Zone.
SUB-DL-UL-MAP	Data Status	Enable, Disable
	OFDMA Symbol Offset	Display only
	OFDMA Subchannel Offset	Display only
	Length	Display only
	FEC Code Type and Modulation Type	<Table 2>
	Repetition Coding Indication	No repetition, 2, 4, 6
	RCID Type	Normal CID, RCID11, RCID7, RCID3
	HARQ ACK offset indicator	0, 1
	DL HARQ ACK offset	0 to 255
	UL HARQ ACK offset	0 to 255
	DL IE Count	Display only
	OFDMA Symbol Offset	0 to 255
	OFDMA Subchannel Offset	0 to 127

Tree	Items	Setting Range	
DL-Burst	Data Status	Enable, Disable	
	OFDMA Symbol Offset	<Table 3>	
	OFDMA Subchannel Offset	0 to 63 (when AMC (2x3), AMC (1x6) excluded) 0 to 255 (when AMC (2x3), AMC (1x6))	
	Boosting	-12, -9, -6, -3, 0, +3, +6, +9 dB	
	No. OFDMA Symbols	2 to 126 symbol (when PUSC), 2 to 126 symbol (when PUSC (all SC)), 1 to 127 symbol (when FUSC), 1 to 127 symbol (when AMC (6x1)), 2 to 126 symbol (AMC (3x2)), 3 to 93 symbol (when AMC (2x3)), 6 to 90 symbol (when AMC (1x6))	
	No. Subchannels	1 to 63	
	Repetition Coding Indication	No repetition, 2, 4, 6 Can be set when FEC Code Type and Modulation Type = QPSK (CC) 1/2, QPSK (CC) 3/4, QPSK (CTC) 1/2, QPSK (CTC) 3/4, QPSK (No Ch Coding); no repetition fixed in other cases	
	FEC Code Type and Modulation Type	<Table 2>	
	Inclusion MAP	Normal, SUB-DL-UL-MAP#n (n = 0 to 2)	
	DL-Burst Data Type	16bit repeat, PN9fix, PN15fix, S_QPSK, S_16QAM, S_64QAM, MAC PDU, User File	
	DL-Burst Data Type Repeat Data	0x0000 to 0xFFFF: Display when DL-Burst Data Type = 16bit repeat	
	DL-Burst Data Type User File	User File selected: Display when DL-Burst Data Type = User File	
	MAC PDU Number	0 to 32	
	Matrix Indicator	Matrix A, Matrix B	
	UL-MAP	Data Status	Enable, Disable
		UL-MAP Type	16bit repeat, PN9fix, PN15fix, S_QPSK, S_16QAM, S_64QAM, UL-MAP, Compressed UL-MAP, User File
		UL-MAP Type Repeat Data	0x0000 to 0xFFFF: Display when UL-MAP Type = 16bit repeat
		UL-MAP Type User File	User File selected: Display when UL-MAP Type = User File
UL-MAP Length		0 to 2037 byte (The calculation value is displayed when UL-MAP Type = UL-MAP or Compressed UL-MAP. The length of payload data for UL-MAP can be set in other cases.)	
UCD Count		0 to 255: Can be set when UL-MAP Type = UL-MAP or Compressed UL-MAP	
Uplink Allocation Start Time		Display only: Set at Common	
UL-MAP IE			
CID		0 to 65535	
UIUC		1 to 10	
UL-Burst Duration		Display only: Set at UL-Burst.	
Repetition Coding Indication		Display only: Set at UL-Burst.	
DCD		Data Status	Enable, Disable
		DCD Offset	0 to (Number of Frames - 1)
		DCD Interval	0 to Number of Frames
	DCD Length	0 to 2037 (without DCD Data Type = TLV) Display only (when DCD Data Type = TLV)	
	DCD Data Type	16bit repeat, PN9fix, PN15fix, S_QPSK, S_16QAM, S_64QAM, User File, TLV	
	Configuration Change Count	0 to 255	
	TLV encoded information		
	Frequency	0 to 6000000 kHz	
	Base Station ID	000000000000 to FFFFFFFF	
	MAC version	1 to 6	
	BS EIRP	-32768 to +32767	
	TTG	Display only	
	RTG	Display only	
	EIRxP_IR_MAX	-32768 to +32767	
	HO Type Support	HO, MDHO, FBSS HO	
	Paging Group ID	0000 to FFFF	
	Trigger Type	0 to 3	
	Trigger Function	0 to 6	
	Trigger Action	1 to 3	
	Trigger Value	00 to FF	
	Trigger averaging Duration	0 to 255	
	BS Restart Count	00 to FF	
	Default RSSI and CINR averaging parameter	00 to FF	
	DL AMC Allocated Physical Bands Bitmap	Display only	
	Hysteresis margin	00 to FF	
Time to trigger duration	00 to FF		
DL-Burst Profile (DIUC = 0 to 12)			
FEC Type	Display only		

MX370105A Mobile WiMAX IQproducer

Optional

MG3710A

Tree	Items	Setting Range	
UCD	Data Status	Enable, Disable	
	UCD Offset	0 to (Number of Frames -1)	
	UCD Interval	0 to Number of Frames	
	UCD Length	0 to 2037 (without UCD Data Type = TLV), Display only (when UCD Data Type = TLV)	
	UCD Data Type	16bit repeat, PN9fix, PN15fix, S_QPSK, S_16QAM, S_64QAM, User File, TLV	
	Configuration Change Count	0 to 255	
	Ranging Backoff Start	0 to 255	
	Ranging Backoff End	0 to 255	
	Request Backoff Start	0 to 255	
	Request Backoff End	0 to 255	
	TLV encoded information		
	Frequency	0 to 6000000 kHz	
	Contention-based Reservation Timeout	00 to FF	
	Start of Ranging Coded Group	00 to FF	
	Band AMC Allocated Threshold	00 to FF	
	Band AMC Release Threshold	00 to FF	
	Band AMC Allocated Timer	00 to FF	
	Band AMC Release Timer	00 to FF	
	Band AMC Status Reporting Max Period	00 to FF	
	Band AMC Retry Timer	00 to FF	
	Normalized C/N Override-2	0000000000000000 to FFFFFFFFFFFFFFFF	
	Use CQICH Indication Flag	00 to FF	
	Handover Ranging Code	00 to FF	
	Initial Ranging Codes	00 to FF	
	Initial Ranging Interval	00 to FF	
	Tx Power Report	0000 to FFFF	
	Normalized C/N for channel Sounding	00 to FF	
	Initial Ranging Backoff Start	00 to FF	
	Initial Ranging Backoff End	00 to FF	
	Bandwidth request Backoff Start	00 to FF	
	Bandwidth request Backoff End	00 to FF	
	Permutation Base	00 to FF	
	UL Allocated Subchannels Bitmap	Display only	
	HARQ Ack Delay for DL burst	00 to FF	
	UL AMC Allocated Physical Bands Bitmap	000000000000 to FFFFFFFFFFFF	
	Size of CQICH-ID field	00 to FF	
	Band-AMC entry average CINR	00 to FF	
	HO ranging start	00 to FF	
	HO ranging end	00 to FF	
	Periodic Ranging Codes	00 to FF	
	Bandwidth Request Codes	00 to FF	
	Periodic Ranging Backoff Start	00 to FF	
Periodic Ranging Backoff End	00 to FF		
CQICH Band AMC Transition Delay	00 to FF		
UL-Burst Profile (UIUC = 1 to 10)			
FEC Type	Display only		
Ranging Data ratio	00 to FF		
MAC PDU	Data Status	Enable, Disable	
	MAC PDU Length	Display only	
	Payload Data Length	0 to 2041 byte (when CI = No CRC), 0 to 2037 byte (when CI = With CRC), 0 to 2047 byte (when CI = Without Header & CRC)	
	CID (Connection Identifier)	0 to 65535	
	CI	With CRC, No CRC, Without Header & CRC	
	CRC Error Insertion	Correct, Error	
	Payload Type	16bit repeat, PN9fix, PN15fix, S_QPSK, S_16QAM, S_64QAM, User File	
	Payload Type Repeat Data	0x0000 to 0xFFFF: Display when Payload Type = 16bit repeat	
	Payload Type User File	User File selected: Display when Payload Type = User File	
MAP-Burst	Data Status	Enable, Disable	
	OFDMA Symbol Offset	<Table 3>	
	OFDMA Subchannel Offset	0 to (Number of Subchannel at Zone)	
	Length	1 to 255 slot	
	Repetition Coding Indication	No Repetition, 2, 4, 6	
FEC Code Type and Modulation Type	<Table 2>		

Tree	Items	Setting Range
MAP-Burst	MAP-Burst Data Type	16bit repeat, PN9fix, PN15fix, S_QPSK, S_16QAM, S_64QAM, MAC PDU, User File
	MAP-Burst Data Type Repeat Data	0x0000 to 0xFFFF: Display when MAP-Burst Data Type = 16bit repeat
	MAP-Burst Data Type User File	User File selected: Display when MAP-Burst Data Type = User File
	MAC PDU Number	0 to 32: Display when MAP-Burst Data Type = MAC PDU.
DL-HARQ Burst	Data Status	Enable, Disable
	RCID_Type	Normal CID, RCID11, RCID7, RCID3
	OFDMA Symbol Offset	<Table 3>
	OFDMA Subchannel Offset	0 to (Number of Subchannel at Zone)
	Boosting	-12, -9, -6, -3, 0, +3, +6, +9 dB
	Rectangular Sub-Burst Indicator	0, 1
	No. OFDMA Symbols	2 to 126 symbol (when PUSC), 2 to 126 symbol (when PUSC (all SC)), 1 to 127 symbol (when FUSC), 1 to 127 symbol (when AMC (6x1)), 2 to 126 symbol (when AMC (3x2)), 3 to 126 symbol (when AMC (2x3)), 6 to 126 symbol (when AMC (1x6))
	No. Subchannels	1 to 127
	Mode	Chase HARQ, MIMO Chase HARQ
	N sub Burst	1 to 16
	N ACK Channel	0 to 15
	Inclusion MAP	Normal, SUB-DL-UL-MAP#n (n = 0 to 2)
	Sub-Burst	Data Status
CID		0 to 65535
Sub-Burst Duration		1 to 1023
Sub-Burst DIUC Indication		0, 1
Repetition Coding Indication		No repetition, 2, 4, 6
FEC Code Type and Modulation Type		<Table 2>
Sub-Burst Data Type		16bit repeat, PN9fix, PN15fix, S_QPSK, S_16QAM, S_64QAM, MAC PDU, User File
Sub-Burst Data Type Repeat Data		0x0000 to 0xFFFF
Sub-Burst Data Type User File		User File selected: Display when Sub-Burst Data Type = User File
MAC PDU Number		0 to 32
MU Indicator		0, 1
Dedicated MIMO DL Control Indicator		0, 1
Matrix Indicator		Matrix A, Matrix B
CRC Error Insertion		Correct, Error
ACID		0 to 15
AL_SN		0, 1
ACK disable		0, 1
Dedicated DL Control Indicator		00, 01, 10, 11
Duration (d)		0 to 15
Allocated Index		0 to 63
Period (p)		0 to 7
Frame Offset	0 to 7	
Dedicated DL Control IE	0 to 1	
No. SDMA layers	1 to 4	

Table 2: FEC Code Type and Modulation Type Setting Range

QPSK (CC) 1/2, QPSK (CC) 3/4, 16QAM (CC) 1/2, 16QAM (CC) 3/4, 64QAM (CC) 1/2, 64QAM (CC) 2/3, 64QAM (CC) 3/4, QPSK (CTC) 1/2, QPSK (CTC) 3/4, 16QAM (CTC) 1/2, 16QAM (CTC) 3/4, 64QAM (CTC) 1/2, 64QAM (CTC) 2/3, 64QAM (CTC) 3/4, 64QAM (CTC) 5/6, QPSK (No Ch Coding), 16QAM (No Ch Coding), 64QAM (No Ch Coding)

Table 3: OFDMA Symbol Offset Setting Range

- 0 to 254 symbol without Preamble at Zone#0 (Select by even symbol.)
- 1 to 255 symbol with Preamble at Zone#0 (Select by odd symbol.)
- (OFDMA Symbol Offset at Zone) to 255 symbol when PUSC Zone from Zone#1 to #7, Resolution 2
- (OFDMA Symbol Offset at Zone) to 255 symbol when PUSC (all SC) Zone, Resolution 2
- (OFDMA Symbol Offset at Zone) to 255 symbol when FUSC Zone, Resolution 1
- (OFDMA Symbol Offset at Zone) to 255 symbol when AMC (6x1) Zone, Resolution 1
- (OFDMA Symbol Offset at Zone) to 255 symbol when AMC (3x2) Zone, Resolution 2
- (OFDMA Symbol Offset at Zone) to 255 symbol when AMC (2x3) Zone, Resolution 3
- (OFDMA Symbol Offset at Zone) to 255 symbol when AMC (1x6) Zone, Resolution 6

MX370105A Mobile WiMAX IQproducer

Optional

MG3710A

PHY/MAC Parameter (Uplink) Setting Range

Tree	Items	Setting Range	
Uplink	Data Status	Enable, Disable	
UL-Zone	Data Status	Enable, Disable	
	Permutation	PUSC, PUSC (without SC rotation), AMC (6x1), AMC (3x2), AMC (2x3), AMC (1x6)	
	Pilot Position	Hopping, Center	
	STC/MIMO	Display only	
	OFDMA Symbol Offset	0 to 255 symbol (Zone#0 = 0)	
	No. OFDMA Symbols	3 to 255 symbol (when PUSC), 3 to 255 symbol (when PUSC (without SC rotation)), 1 to 255 symbol (when AMC (6x1)), 2 to 254 symbol (when AMC (3x2)), 3 to 255 symbol (when AMC (2x3)), 6 to 252 symbol (AMC (1x6))	
	UL-PermBase	0 to 69	
	UL-Burst Number	1 to 16	
	UL-Burst	Data Status	Enable, Disable
		OFDMA Symbol Offset	<Table 4>
OFDMA Subchannel Offset		0 to (Number of subchannels set for zone - 1)	
UL Burst Duration		3 to 3069 symbol (when PUSC), 3 to 3069 symbol (when PUSC (without SC rotation)), 1 to 1023 symbol (when AMC (6x1)), 2 to 2046 symbol (when AMC (3x2)), 3 to 3069 symbol (when AMC (2x3)), 6 to 6138 symbol (when AMC (1x6))	
Burst Power Offset		-10.00 to +10.00 dB	
Pilot Pattern		Normal, Pattern A, Pattern B	
Repetition Coding Indication		No repetition, 2, 4, 6 Can be set when FEC Code Type and Modulation Type = QPSK (CC) 1/2, QPSK (CC) 3/4, QPSK (CTC) 1/2, QPSK (CTC) 3/4, QPSK (No Ch Coding); no repetition fixed in other cases	
FEC Code Type and Modulation Type		<Table 5>	
Inclusion MAP		Normal, SUB-DL-UL-MAP#n (n = 0 to 2)	
UL-Burst Data Type		16bit repeat, PN9fix, PN15fix, S_QPSK, S_16QAM, S_64QAM, MAC PDU, User File	
UL-Burst Data Type Repeat Data		0x0000 to 0xFFFF: Display when UL-Burst Data Type = 16bit repeat	
UL-Burst Data Type User File		User File selected: Display when UL-Burst Data Type = User File	
MAC PDU Number		0 to 32	
MAC PDU		<See MAC PDU on Downlink>	
UL-HARQ Burst		Data Status	Enable, Disable
		RCID_Type	Normal CID, RCID11, RCID7, RCID3
		OFDMA Symbol Offset	<Table 4>
	OFDMA Subchannel Offset	0 to (Subchannel number -1 at Zone)	
	Mode	Chase HARQ (Display only)	
	Allocated Start Indication	0, 1	
	N sub Burst	1 to 16	
	Inclusion MAP	Normal, SUB-DL-UL-MAP#n (n = 0 to 2)	
	Sub-Burst	Data Status	Enable, Disable
CID		0 to 65535	
FEC Code Type and Modulation Type		<Table 5>	
Repetition Coding Indication		No repetition, 2, 4, 6	
Sub-Burst Duration		1 to 1023 slot	
Sub-Burst Data Type		16bit repeat, PN9fix, PN15fix, S_QPSK, S_16QAM, S_64QAM, MAC PDU, User File	
Sub-Burst Data Type Repeat Data		0x0000 to 0xFFFF	
Sub-Burst Data Type User File		User File selected: Display when Sub-Burst Data Type = User File	
MAC PDU Number		0 to 32	
CRC Error Insertion		Correct, Error	
Dedicated UL Control Indicator		0, 1	
SDMA Control Info bit		0, 1	
Num SDMA layers		0 to 3	
Pilot Pattern		Pattern A, Pattern B, Pattern C, Pattern D	
ACID		0 to 15	
AI_SN		0, 1	
ACK disable		0, 1	

Tree	Items	Setting Range	
Initial/ Handover Ranging Region	Data Status	Enable, Disable	
	OFDMA Symbol Offset	<Table 6>	
	OFDMA Subchannel Offset	0 to 126 (when PUSC, PUSC (without SC rotation)) 0 to 120 (without PUSC, PUSC (without SC rotation))	
	No. OFDMA Symbols	3 to 126 symbol (when PUSC), 3 to 126 symbol (when PUSC (without SC rotation)), 1 to 127 symbol (when AMC (6×1)), 2 to 126 symbol (when AMC (3×2)), 3 to 126 symbol (when AMC (2×3)), 6 to 126 symbol (when AMC (1×6))	
	No. Subchannels	6 to 126 (when PUSC, PUSC (without SC rotation)) 8 to 120 (without PUSC, PUSC (without SC rotation))	
	Initial/Handover Ranging Symbols	2, 4	
	Initial/Handover Ranging Burst Number	1 to 16	
	Ranging Region Combination	Non, Combine	
	BW Request/Periodic Ranging Offset	0 to No. OFDMA Symbols at Initial/Handover Ranging Region	
	BW Request/Periodic Ranging Symbols	1, 3	
	BW Request/Periodic Ranging Burst Number	0 to 16	
Initial/ Handover Ranging Burst	Data Status	Enable, Disable	
	OFDMA Symbol Offset	0 to 254 symbol (When Initial/Handover Ranging Symbols = 2), Setting resolution = 2 0 to 252 symbol (When Initial/Handover Ranging Symbols = 4), Setting resolution = 4	
	OFDMA Subchannel Offset	0 to 126 (when PUSC, PUSC (without SC rotation)) 0 to 120 (without PUSC, PUSC (without SC rotation))	
	No. OFDMA Symbols	Display only	
	No. Subchannels	Display only	
	Ranging Power Offset	-10.00 to +10.00 dB	
	Ranging Code Number	0 to 255	
BW Request/ Periodic Ranging Region	Data Status	Enable, Disable	
	OFDMA Symbol Offset	<Table 6>	
	OFDMA Subchannel Offset	0 to 126 (when PUSC, PUSC (without SC rotation)) 0 to 120 (without PUSC, PUSC (without SC rotation))	
	No. OFDMA Symbols	3 to 126 symbol (when (PUSC)), 3 to 126 symbol (when PUSC (without SC rotation)), 1 to 127 symbol (when AMC (6×1)), 2 to 126 symbol (when AMC (3×2)), 3 to 126 symbol (when AMC (2×3)), 6 to 126 symbol (when AMC (1×6))	
	No. Subchannels	6 to 126 (when PUSC, PUSC (without SC rotation)) 8 to 120 (without PUSC, PUSC (without SC rotation))	
	BW Request/Periodic Ranging Symbols	1, 3	
	BW Request/Periodic Ranging Burst Number	1 to 16	
BW Request/ Periodic Ranging Burst	Data Status	Enable, Disable	
	OFDMA Symbol Offset	0 to 255 symbol	
	OFDMA Subchannel Offset	0 to 126 (when PUSC, PUSC (without SC rotation)) 0 to 120 (without PUSC, PUSC (without SC rotation))	
	No. OFDMA Symbols	Display only	
	No. Subchannels	Display only	
	Ranging Power Offset	-10.00 to +10.00 dB	
Fast- Feedback Region	Data Status	Enable, Disable	
	OFDMA Symbol Offset	(OFDMA Symbol Offset at Zone) to 255 symbol, in 3-symbol steps	
	OFDMA Subchannel Offset	0 to 127	
	No. OFDMA Symbols	3 to 126 symbol	
	No. Subchannels	1 to 127	
	Fast-Feedback Type	Display only	
	Fast-Feedback Burst Number	1 to 32	
	Fast- Feedback Burst	Data Status	Enable, Disable
		OFDMA Symbol Offset	0 to 255 symbol
		OFDMA Subchannel Offset	0 to 127
No. OFDMA Symbols		Display only	
No. Subchannels		Display only	
Ranging Power Offset		-10.00 to +10.00 dB	
UL-ACK Region	Payload	000000 to 111111	
	Data Status	Enable, Disable	
	OFDMA Symbol Offset	(OFDMA Symbol Offset at Zone) to 255 symbol	
	OFDMA Subchannel Offset	0 to 127	
	No. OFDMA Symbols	3 to 126 symbol	
	No. Subchannels	1 to 127	
	UL-ACK Burst Number	1 to 32	

MX370105A Mobile WiMAX IQproducer

Optional

MG3710A

Tree	Items	Setting Range
UL-ACK Burst	Data Status	Enable, Disable
	OFDMA Symbol Offset	0 to 255 symbol, in 3-symbol steps
	OFDMA Subchannel Offset	0 to 127
	No. OFDMA Symbols	Display only
	No. Subchannels	Display only
	Occupied half subchannel	even, odd
	UL-ACK Burst Power Offset	-10.0 to +10.0 dB
	Payload	ACK, NACK
Sounding Zone	Data Status	Enable, Disable
	OFDMA Symbol Offset	0 to 255 symbol
	No. OFDMA Symbols	1 to 8
	Sounding Type	Type A (Display only)
	Send Sounding Report Flag	0, 1
	Sounding Relevance Flag	0, 1
	Sounding Relevance	0, 1
	Include additional feedback	No additional feedback, Channel coefficients, Received pilot coefficients, Feedback message
	Shift Value	0 to 127
	Sounding Symbol	Data Status
Separability Type		All subcarriers, Decimated subcarriers
Max. Cyclic Shift Index P		4, 8, 16, 32, 9, 18
Decimated Value D		2, 4, 8, 16, 32, 64, 128, 5
Decimated offset randomization		No randomization, Pseudo-randomly
Sounding Symbol Index		1 to 8
Number of CIDs		1 to 128
CID	Data Status	Enable, Disable
	Shorted Basic CID	0 to 4095
	Power Assignment Method	Equal power, Per subcarrier power limit, Total power limit
	Power Boost	No power boost, Power boost
	Multi-Antenna Flag	First antenna only, All antennas
	Allocated Mode	Normal, Band
	Start Frequency Band	0 to 95 (when FFT Size = 2048), 0 to 47 (when FFT Size = 1024), 0 to 23 (when FFT Size = 512), 0 to 5 (when FFT Size = 128)
	No. Frequency Bands	1 to 96 (when FFT Size = 2048), 1 to 48 (when FFT Size = 1024), 1 to 24 (when FFT Size = 512), 1 to 6 (when FFT Size = 128)
	Band Bitmap	0 to FFF (when FFT Size = 2048, 1024, 512), 0 to 7 (when FFT Size = 128)
	Sounding Relevance	0, 1
	Cyclic time shift index m	0 to (Max Cyclic Shift Index P-1 at Sounding Symbol that CID belongs to)
	Decimated Offset d	0 to (Decimated Value D-1 at Sounding Symbol that CID belongs to)
	Use same symbol for additional feedback	0, 1
	Periodicity	Single, 1, 2, 4

Table 4: OFDMA Symbol Offset Setting Range

PUSC Zone: [OFDMA Symbol Offset of the zone] to [OFDMA Symbol Offset + No. OFDMA Symbols of the zone] symbols, Setting resolution: 3
 PUSC (w/o SC rotation) Zone: [OFDMA Symbol Offset of the zone] to [OFDMA Symbol Offset + No. OFDMA Symbols of the zone] symbols, Setting resolution: 3
 AMC (6 × 1) Zone: [OFDMA Symbol Offset of the zone] to [OFDMA Symbol Offset + No. OFDMA Symbols of the zone] symbols, Setting resolution: 1
 AMC (3 × 2) Zone: [OFDMA Symbol Offset of the zone] to [OFDMA Symbol Offset + No. OFDMA Symbols of the zone] symbols, Setting resolution: 2
 AMC (2 × 3) Zone: [OFDMA Symbol Offset of the zone] to [OFDMA Symbol Offset + No. OFDMA Symbols of the zone] symbols, Setting resolution: 3
 AMC (1 × 6) Zone: [OFDMA Symbol Offset of the zone] to [OFDMA Symbol Offset + No. OFDMA Symbols of the zone] symbols, Setting resolution: 6

Table 5: FEC Code Type and Modulation Type Setting Range

QPSK (CC) 1/2, QPSK (CC) 3/4, 16QAM (CC) 1/2, 16QAM (CC) 3/4, 64QAM (CC) 1/2, 64QAM (CC) 2/3, 64QAM (CC) 3/4,
 QPSK (CTC) 1/2, QPSK (CTC) 3/4, 16QAM (CTC) 1/2, 16QAM (CTC) 3/4, 64QAM (CTC) 1/2, 64QAM (CTC) 2/3, 64QAM (CTC) 3/4, 64QAM (CTC) 5/6,
 QPSK (No Ch Coding), 16QAM (No Ch Coding), 64QAM (No Ch Coding)

Table 6: OFDMA Symbol Offset Setting Range

PUSC Zone: [OFDMA Symbol Offset of the zone] to 255 symbols, Setting resolution: 3
 PUSC (w/o SC rotation) Zone: [OFDMA Symbol Offset of the zone] to 255 symbols, Setting resolution: 3
 AMC (6 × 1) Zone: [OFDMA Symbol Offset of the zone] to 255 symbols, Setting resolution: 1
 AMC (3 × 2) Zone: [OFDMA Symbol Offset of the zone] to 255 symbols, Setting resolution: 2
 AMC (2 × 3) Zone: [OFDMA Symbol Offset of the zone] to 255 symbols, Setting resolution: 3
 AMC (1 × 6) Zone: [OFDMA Symbol Offset of the zone] to 255 symbols, Setting resolution: 6

MX370106A DVB-T/H IQproducer



Optional

MG3710A

The MX370106A DVB-T/H IQproducer is GUI-driven PC application software supporting the ETSI EN 300 744 V1.5.1 (2004-11) Physical Layer standard.

This software processes the DVB-T/H Physical Layer shown in the Signal Generation Block Diagram below.

When all of Outer Coders, Outer Interleaver, Inner Coder, and Inner Interleaver are ON, the data selected by Data Pattern is input to the MPEG-TS part shown in the figure below.

When each function is turned OFF, all the blocks of the front side are turned OFF. The data selected by Data Pattern is inserted by jumping over blocks that are OFF.

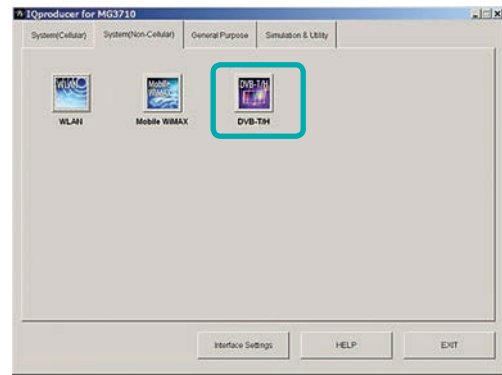

IQproducer Main Screen

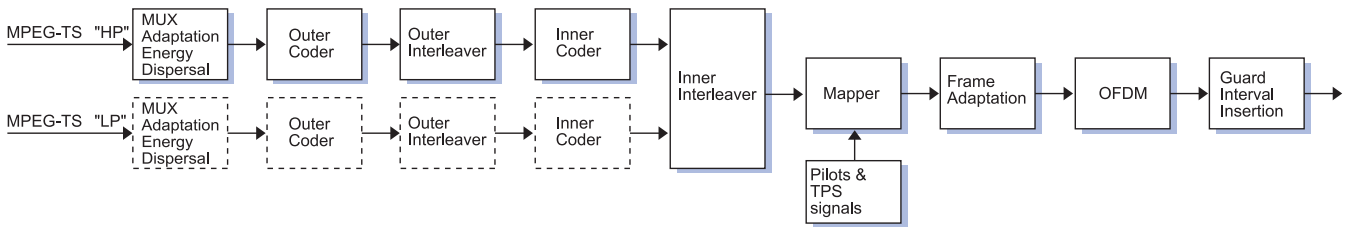

• **DVB-T/H IQproducer Setting Screen**

Parameters are set easily by selecting buttons on one screen.

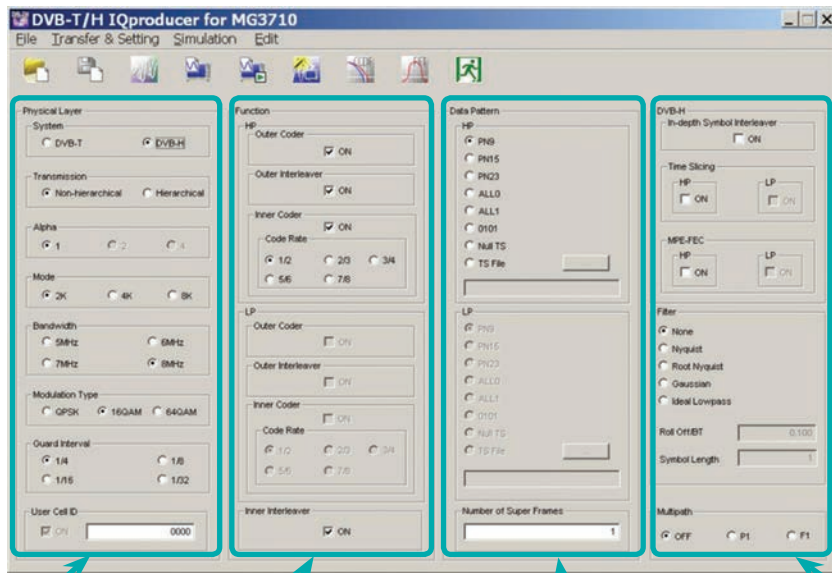

Physical Layer:
Sets System, Transmission, Mode, Sub-carrier number, Bandwidth, Modulation Type and Guard Interval

Function:
Sets
• Outer Coder
• Outer Interleaver
• Inner Coder
• Code Rate
• Inner Interleaver

Data Pattern:
Sets data
When "TS File" is selected, an arbitrary MPEG-2TS file (binary data with re-multiplexed video and audio) is loaded to generate a waveform pattern. It is used for video evaluation.

DVB-H:
Sets
• In-depth Symbol Interleaver
• Time Slicing
• MPE-FEC
Filter:
Multipath:

MX370106A DVB-T/H IQproducer

Optional

MG3710A

● Parameter Setting Items

No.	Segment	Items	Setting Range	Restriction*1
1	Physical Layer	System	DVB-T, DVB-H	
2		Transmission	Non-hierarchical, Hierarchical	
3		Alpha	1, 2, 4	1: When No.2 = Non-hierarchical
4		Mode	2K, 4K, 8K (Sub-carrier of OFDM)	"4K" cannot be set when No.1 = DVB-T.
5		Bandwidth	5, 6, 7, 8 MHz	"5 MHz" cannot be set when No.1 = DVB-T.
6		Modulation Type	QPSK, 16QAM, 64QAM	"QPSK" cannot be set when No.2 = Hierarchical
7		Guard Interval	1/4, 1/8, 1/16, 1/32	
8		User Cell ID	ON (0000 to FFFF), OFF	"ON": When No.1 = DVB-H
9	Function	Outer Coder	ON, OFF	"LP" cannot be set when No.2 = Non-hierarchical. OFF: When No.10 = OFF
10		Outer Interleaver	ON, OFF	"LP" cannot be set when No.2 = Non-hierarchical. ON: When No.9 = ON OFF: When No.11 = OFF
11		Inner Coder	ON, OFF	"LP" cannot be set when No.2 = Non-hierarchical. ON: When No.10 = ON OFF: When No.13 = OFF
12		Code Rate	1/2, 2/3, 3/4, 5/6, 7/8	"LP" cannot be set when No.2 = Non-hierarchical. Cannot be set when No.11 = OFF
13		Inner Interleaver	ON, OFF	ON: When No.11 = ON
14	Data Pattern	(Data)	PN9, PN15, PN23, ALL0, ALL1, 0101, Null TS, TS File When TS File is selected, a created TS (Transport Stream: binary data in which image data and voice data are multiplexed) data file can be loaded. TS data consists of two or more packets (1 packet = 188 bytes). The first byte of each packet is the Sync Byte, and is always 47 (hexadecimal). If a file that does not satisfy this TS data format is selected and the Calculation button is clicked, an error message will be displayed. The Sync Byte is also added to PN9, PN15, PN23, ALL0, ALL1, and 0101 data patterns when Outer Coder, Outer Interleaver, Inner Coder, and Inner Interleaver are all set to ON. At this time, the last data in a packet and the data following the Sync Byte in the next packet are continuous.*2	"LP" cannot be set when No.2 = Non-hierarchical.
15		Number of Super Frames	1 to 384	(See following for details.)
16	DVB-H	In-depth Symbol Interleaver	ON, OFF	OFF: When No.1 = DVB-T OFF: When No.4 = 8K OFF: When No.13 = OFF
17		Time Slicing	ON, OFF When Time Slicing = ON, the 49th bit of the TPS data is set to "1". When Data Pattern = TS File, Time Slicing processing is required in the selected TS file.	OFF: No.1 = DVB-T "LP" cannot be set when No.2 = Non-hierarchical.
18		MPE-FEC	ON, OFF When MPE-FEC = ON, the 50th bit of the TPS data is set to "1". When Data Pattern = TS File, MPE-FEC processing is required in the selected TS file.	OFF: When No.1 = DVB-T "LP" cannot be set when No.2 = Non-hierarchical.
19	Filter	(Type)	None, Nyquist, Root Nyquist, Gaussian, Ideal Lowpass	
20		Roll Off/BT	0.100 to 1.000	Cannot be set when No.19 = None/Ideal Lowpass
21		Symbol Length	1 to 1023	Cannot be set when No.19 = None/Ideal Lowpass 1: When No.19 = None 1023: When No.19 = Ideal Lowpass
22	Multipath		OFF, F1, P1	

*1: Other parameter setting conditions limited by setting range restrictions.

*2: Packet continuity shown in following figure.

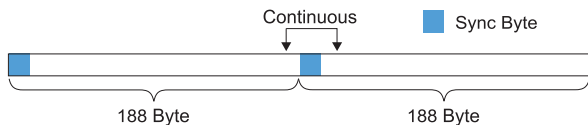

● Number of Super Frame Setting

The "Number of Super Frame" setting range changes according to the "Mode" setting, "MG3710A main frame memory option" and "Combination of baseband signal option" as shown in the following table.

Maximum Number of Super Frames	Select Option	Mode
48	Memory 64 Msamples*1	2K
24		4K
12		8K
96	Memory 64 Msamples × 2*1 (With Combination of Baseband Signal Option)*4	2K
48		4K
24		8K
192	Memory 256 Msamples*2	2K
96		4K
48		8K
385	Memory 256 Msamples × 2*2 (With Combination of Baseband Signal Option)*4	2K
192		4K
96		8K
385	Memory 1024 Msamples*3	2K
192		4K
96		8K
385	Memory 1024 Msamples × 2*3 (With Combination of Baseband Signal Option)*4	2K
192		4K
96		8K

*1: Standard built-in memory size

*2: MG3710A-045 ARB Memory Upgrade 256 Msample for 1stRF
 MG3710A-075 ARB Memory Upgrade 256 Msample for 2ndRF

*3: MG3710A-046 ARB Memory Upgrade 1024 Msample for 1stRF
 MG3710A-076 ARB Memory Upgrade 1024 Msample for 2ndRF

*4: Supports two built-in ARB memories for one RF output (1stRF or 2ndRF)
 (one ARB memory as standard).

Combines two memories to support either two waveform patterns or large waveform pattern with upper limit size of 1024 Msamples.

The data selected by "Data Pattern" is annulled in the terminal of the final super frame set here. The data processing changes according to the "Size of TS File" and "Setting of Number of Super Frames" when TS File is selected at "Data Pattern". The TS File data is annulled when the "TS File data number" is greater than the "Data number equivalent to the set number of super frames." When the "TS File data number" is smaller than the "Data number equivalent to the set number of super frames", the same TS File data is repeated from the header.

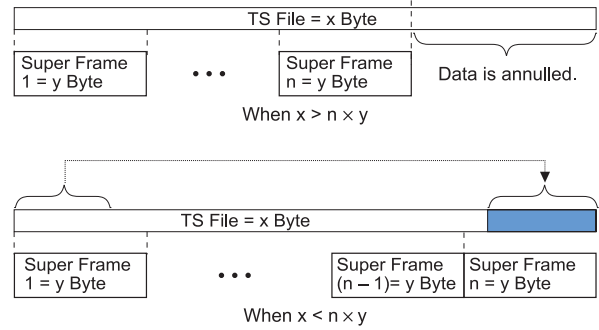

MX370107A Fading IQproducer



Optional

MG3710A

MG3740A

The MX370107A Fading IQproducer is GUI-driven PC application software to set fading parameters and to generate waveform patterns by reading the waveform patterns for the MG3710A/MG3740A. The MX370107A supports the fading of each IQ channel, calculation of correlation line, AWGN combination. Either waveform patterns created by another IQproducer or IQ data (ASCII) created by general simulation tools can be selected as the input data file.

- **Fading Profile Selection Function**
Sets fading profile, movement speed, and Doppler frequency for channels. "Select Profile" has profiles for each system to batch set parameters with a single click. Set parameters can be edited at the Channel Setting screen.

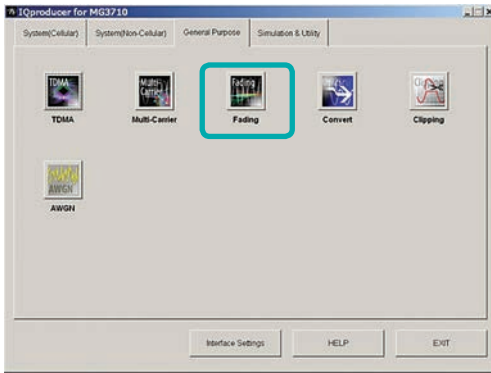

IQproducer Main Screen

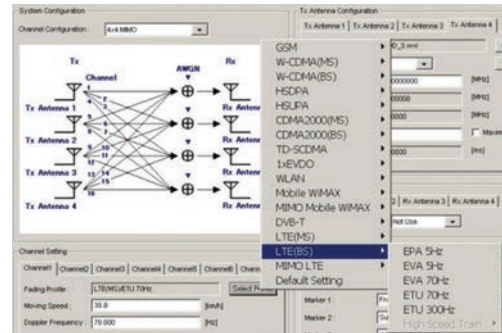

Select Profile (Example: LTE_BS)

- **Fading IQproducer Setting Screen**
The Tx, Rx, Channel, and AWGN are set at the common screen shown on the right. The channel configuration can be selected from 1x1 SISO to 4x4 MIMO. Each channel path number (1 to 20), fading type, delay, and power is set at the Channel 1 to Channel 4 tabs.

- 1x1 SISO
- 1x2 SIMO
- 1x3 SIMO
- 1x4 SIMO
- 2x1 MISO
- 2x2 MIMO
- 2x3 MIMO
- 2x4 MIMO
- 3x1 MISO
- 3x2 MIMO
- 3x3 MIMO
- 3x4 MIMO
- 4x1 MIMO
- 4x2 MIMO
- 4x3 MIMO
- 4x4 MIMO

Channel Setting:
Sets fading profile, movement speed, Doppler frequency for channels.

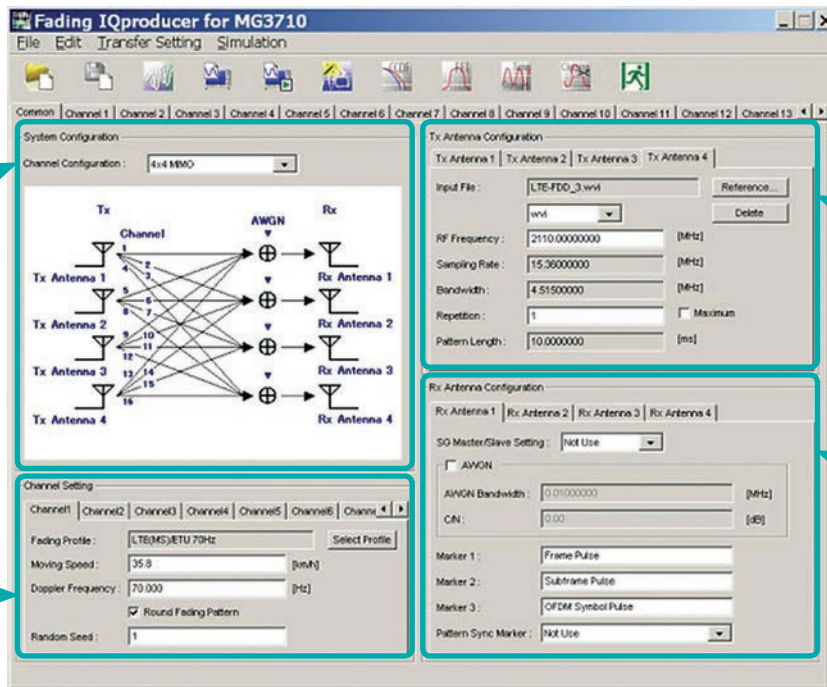

Tx Antenna Setting:
Sets Tx signals and can select waveform patterns or any IQ data (ASCII type) for the MG3710A.

Rx Antenna Setting:
Sets AWGN addition on/off and Master/Slave Rx.

Fading IQproducer Setting Screen/Common Sheet

- Channel Setting

Channel tab sets max. 20 paths and parameter details for each channel to confirm level difference and delay on graph.

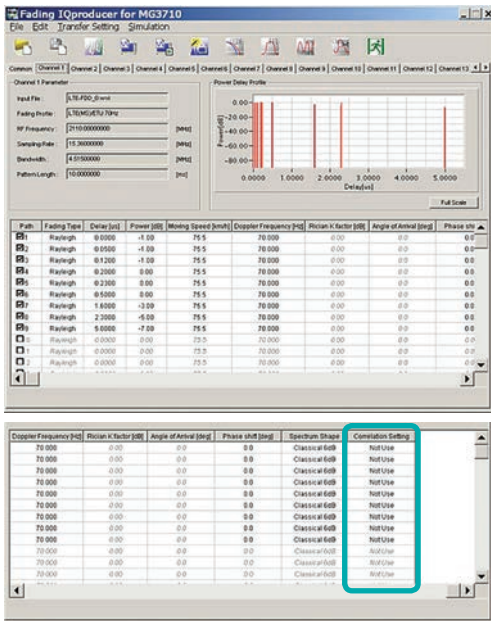

Channel Sheet

- Correlation Matrix Setting

Parameter of Channel tab for all enabled paths. Automatically sets bottom left element so that top right and bottom left elements become complex conjugates where opposite components of Correlation Matrix form boundary.

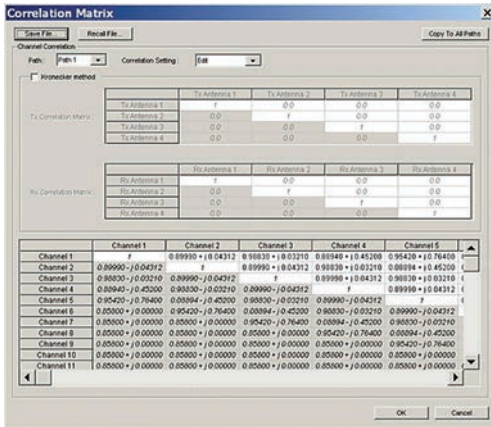

Correlation Matrix Screen

- Moving Propagation Setting

Can be set when:

- “System Configuration = 1x1 SISO”,
- “Fading Profile = Moving Propagation (W-CDMA)”

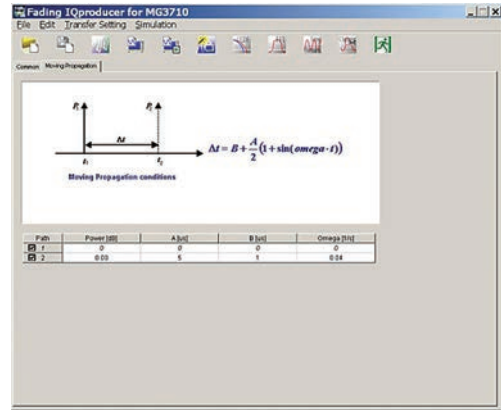

Moving Propagation Screen

- Birth-Death Propagation Setting

Can be set when:

- “System Configuration = 1x1 SISO”,
- “Fading Profile = Birth-Death Propagation (W-CDMA)”

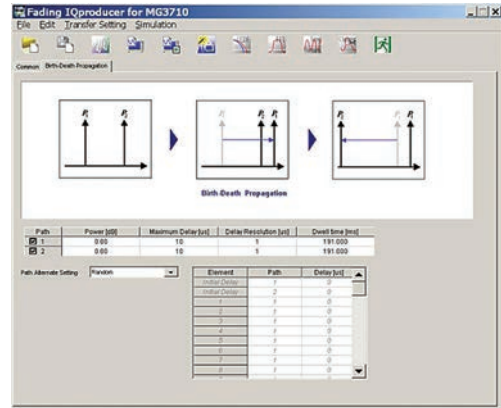

Birth-Death Propagation Screen

MX370107A Fading IQproducer

Optional

MG3710A

MG3740A

Common Parameter Setting Range

Items	Outline	Setting Range
System Configuration		
Channel Configuration	Number of Input/Output antenna	1x1 SISO, 1x2 SIMO, 1x3 SIMO, 1x4 SIMO, 2x1 MISO, 2x2 MIMO, 2x3 MIMO, 2x4 MIMO, 3x1 MISO, 3x2 MIMO, 3x3 MIMO, 3x4 MIMO, 4x1 MISO, 4x2 MIMO, 4x3 MIMO, 4x4 MIMO
Tx Antenna Configuration		
Input File	Input pattern file	Display only
	Input file type	wvi, ASCII1, ASCII2, ASCII3
RF Frequency	Center frequency	0.25000000 to 6000.00000000 MHz, Resolution 0.00000001 MHz
Sampling Rate	Sampling Rate	When wvi file is selected: Display only When ASCII1/ASCII2/ASCII3 is selected: 0.02000000 MHz to 160.00000000 MHz [MG3710A] 0.02000000 MHz to 8.00000000 MHz [MG3740A] Resolution: 0.00000001 MHz
Bandwidth	Bandwidth of waveform pattern	When wvi file is selected: Display only When ASCII1/ASCII2/ASCII3 is selected: 0.02000000 to Sampling Rate MHz, Resolution 0.00000001 MHz
Repetition	Repetition number of waveform pattern	1 to maximum, Maximum (at maximum, waveform patterns repeated up to memory size)
Pattern Length	Pattern length of waveform pattern	Display only
Channel Setting		
Fading Profile	Display of Fading Profile	<Table 1>
Moving Speed	Moving Speed	0.0 to 5000.0 km/h, Resolution 0.1 km/h
Doppler Frequency	Doppler Frequency	0.000 to "Sampling Rate/2 or Following Equation: smaller" Resolution 0.001 Hz Equation: $5000 \times 1000/3600 \times [\text{RF Frequency}]/c$ (c: Speed of light)
Round Fading Pattern	Continuity of faded waveform pattern	With/Without check (setting check makes sequential)
Random Seed	Random seed for fading	1 to 255, Resolution 1
Rx Antenna Configuration		
SG Master/Slave Setting	Master/Slave setting when connecting two SG units at SIMO/MIMO	Not Use, Master, Slave (Slave1 to Slave3)
AWGN	ON/OFF	With check (= ON)/Without check (= OFF)
AWGN Bandwidth	AWGN Bandwidth	0.01000000 to Sampling Rate/2 MHz, Resolution 0.00000001 MHz
C/N	Setting of C/N	-40.00 to +40.00 dB, Resolution 0.01 dB
Marker1 to 3	Marker name	31 characters max
Pattern Sync Marker	Marker for output of Pattern Sync Marker	Not Use, Marker1, Marker2, Marker3

Table 1: Fading Profile Channel Model

System	Channel Model
GSM	Rural Area 6 tap, Rural Area 4 tap, Hilly Terrain 12 tap-1, Hilly Terrain 12 tap-2, Hilly Terrain 6 tap-1, Hilly Terrain 6 tap-2, Urban Area 12 tap-1, Urban Area 12 tap-2, Urban Area 6 tap-1, Urban Area 6 tap-2, Equalisation Test 6 tap, Typical small cell 2 tap
W-CDMA (MS)	Case1, Case2, Case3, Case4, Case5, Case6, Moving propagation, Birth-Death propagation, High Speed Train
W-CDMA (BS)	Case1, Case2, Case3, Case4, Moving propagation, Birth-Death propagation, High Speed Train
HSDPA	Case1, Case2, Case3, Case4, Case5, Case6, Case8, ITU Pedestrian A, ITU Pedestrian B, ITU Vehicular A
HSUPA	Case1, Case2, Case3, Case4, ITU Pedestrian A, ITU Pedestrian B, ITU Vehicular A
CDMA2000 (MS)	Case1, Case2, Case3, Case4, Case5, Case6
CDMA2000 (BS)	Case1, Case2, Case3, Case4
TD-SCDMA	Case1, Case2, Case3, ITU Pedestrian A, ITU Pedestrian B, ITU Vehicular A
1xEV-DO	Configuration1, Configuration2, Configuration3, Configuration4, Configuration5
WLAN	Model A, Model B, Model C, Model D, Model E
Mobile WiMAX	ITU Pedestrian B, ITU Vehicular A, Large delay spread
MIMO Mobile WiMAX	2x2 MIMO (ITU Pedestrian B, ITU Vehicular A, Large delay spread)
DVB-T	Typical Urban (TU6), Typical Rural Area (RA6)
LTE (MS)	EPA 5 Hz, EVA 5 Hz, EVA 70 Hz, ETU 70 Hz, ETU 300 Hz, High Speed Train
LTE (BS)	EPA 5 Hz, EVA 5 Hz, EVA 70 Hz, ETU 70 Hz, ETU 300 Hz, High Speed Train
MIMO LTE	1x2 SIMO (EPA 5 Hz, EVA 5 Hz, EVA 70 Hz, ETU 70 Hz, ETU 300 Hz) 2x2 MIMO (EPA 5 Hz, EVA 5 Hz, EVA 70 Hz, ETU 70 Hz, ETU 300 Hz) 4x2 MIMO (EPA 5 Hz, EVA 5 Hz, EVA 70 Hz, ETU 70 Hz, ETU 300 Hz) 4x4 MIMO (EPA 5 Hz, EVA 5 Hz, EVA 70 Hz, ETU 70 Hz, ETU 300 Hz)

● Channel 1 to 16 Parameter Setting Range

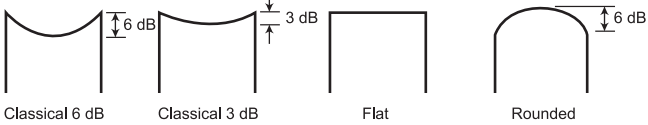
Items	Outline	Setting Range
Channel n parameters (n = 1 to 16)		
Input File	Input File	Display only
Fading Profile	Fading Profile	Display only
RF Frequency	Center Frequency	Display only
Sampling Rate	Sampling Rate	Display only
Bandwidth	Bandwidth of waveform pattern	Display only
Pattern Length	Pattern Length of waveform pattern	Display only
Path (1 to 20)		
Path	Display of Path No., ON/OFF	With check (= ON)/Without check (OFF)
Fading Type	Kinds of single path fading	Rayleigh, Rice, Constant Rayleigh: Environment in which multiple scattering waves arrive. The Rx level is changed according to the Rayleigh distribution. Rice: Environment in which multiple scattering and direct waves arrive. The Rx level is changed according to the Rice distribution. Constant: Rx level not changed
Delay	Delay	0.0000 to 2000.0000 μ s, Resolution 0.0001 μ s
Power	Power of path	-80.00 to 0.00 dB, Resolution 0.01 dB
Moving Speed	Moving Speed	0.0 to 5000.0 km/h, Resolution 0.1 km/h
Doppler Frequency	Doppler Frequency	0.000 to Sampling Rate/2 or smaller, Resolution 0.001 Hz Equation: $5000 \times 1000/3600 \times [RF \text{ Frequency}]/c$ (c: velocity of light)
Rician K factor	Power ratio between direct wave and scattering wave	-40.00 to +40.00 dB, Resolution 0.01 dB Can be set when Fading Type = Rice.
Angle of Arrival	Direct wave arrival angle	0.0 to 180.0 deg., Resolution 0.1 deg. Can be set when Fading Type = Rice.
Phase Shift	Phase Shift	0.0 to 359.9 deg., Resolution 0.1 deg.
Spectrum Shape	Doppler spectrum shape	Classical 6 dB, Classical 3 dB, Flat, Rounded Can not be set when Fading Type = Constant. 
Correlation Setting	Setting correlation matrix	Edit, Not Use, Path number setting at Edit
Path Correlation Matrix	Path Correlation Matrix	-1.00000 -j1.00000 to 1.00000 +j1.00000 Resolution both real and imaginary parts = 0.00001 Set when Correlation Setting = Edit Only top-right elements of opposite angle can be edited

● Moving Propagation Parameter Setting Range

Can be set when "System Configuration = 1x1 SISO" and "Fading Profile = Moving Propagation".

Items	Outline	Setting Range
Power	Power of Path2	-80.00 to 0.00 dB, Resolution 0.01 dB
A (Offset)	Offset of Path2	0 to 500 μ s, Resolution 1 μ s
B (Variation)	Change of delay at Path 2	0 to 500 μ s, Resolution 1 μ s
Omega	Setting of Omega	0.00 to 1.00 Hz, Resolution 0.01 Hz

● Birth-Death propagation Parameter Setting Range

Can be set when "System Configuration = 1x1 SISO" and "Fading Profile = Birth-Death Propagation".

Items	Outline	Setting Range
Power	Power of path	-80.00 to 0.00 dB, Resolution 0.01 dB
Maximum Delay	Maximum Delay	1 to 400 μ s, Resolution "Delay Resolution"
Delay Resolution	Delay Resolution	1 to Maximum Delay μ s, Resolution 1 μ s
Dwell time	Dwell time	0.001 to 200.000 ms, Resolution 0.001 ms
Path Alternate setting	Path Alternate setting	Random, Sequence Random: Path 1 and Path 2 alternated randomly Sequence: Delay and path switched by setting sequence
Path	Path setting	1, 2, Termination Can be set when Path Alternate Setting = Sequence.
Delay	Delay of path	0 to Maximum Delay Enabled when Path Alternate = Sequence and previous element \neq Termination

● High Speed Train Parameter Setting Range

Can be set when "System Configuration = 1x1 SISO" and "Fading Profile = High Speed Train".

Items	Outline	Setting Range
Ds	Setting of (the default value of the distance between BS and train) \times 2	0 to 2000 m, Resolution: 1 m
Dmin	Setting of the distance between BS and rail	1 to 100 m, Resolution: 1 m
Rician K factor	Power ratio between direct wave and scattering wave	-40.00 to +40.00 dB, Resolution: 0.01 dB
Moving Speed		0.0 to 5000.0 km/h, Resolution: 0.1 km/h
Maximum Doppler Frequency		0.000 to 2000.000 Hz, Resolution: 0.001 Hz

MX370108A LTE IQproducer MX370108A-001 LTE-Advanced FDD Option



Optional

MG3710A

The MX370108A LTE IQproducer is PC application software with a GUI for generating waveform patterns in compliance with the LTE FDD specifications in the 3GPP TS 36.211, TS 36.212, and TS 36.213 standards.

Generates test model waveform patterns used for LTE base station Tx tests and FRC (Fixed Reference Channel) used for Rx tests. LTE IQproducer supports two setting screens: "Easy Setup Screen" and "Normal Setup Screen".

The MX370108A-001 LTE-Advanced FDD option supports simple generation of carrier aggregation signals added* by 3GPP Rel. 10. Additionally, clustered SC-FDMA signals can be generated at Uplink.

*: MBSFN reference signals, UE-specific reference signals, Positioning reference signals, CSI reference signals, and Physical Multicast Channel are not supported.

Channels Generated by MX370108A LTE IQproducer

- Downlink**
- Cell-specific Reference Signal
 - Primary Synchronization Signal
 - Secondary Synchronization Signal
 - PBCH (Physical Broadcast Channel)
 - PCFICH (Physical Control Format Indicator Channel)
 - PDCCH (Physical Downlink Control Channel)
 - PDSCH (Physical Downlink Shared Channel)
 - PHICH (Physical Hybrid-ARQ Indicator Channel)

- Uplink**
- PUCCH (Physical Uplink Control Channel)
 - PUSCH (Physical Uplink Shared Channel)
 - Demodulation Reference Signal for PUCCH/PUSCH
 - Sounding Reference Signal
 - Random Access Preamble

Easy Setup Screen

Waveform patterns can be generated easily because the main parameters are restricted to the Easy Setup screen. Use "Normal Setup function" for detailed parameter settings.

The screenshot shows the 'Easy Setup Screen (Example: FRC_UL)' with several parameter windows highlighted by arrows:

- E-UTRA Test Models by Signal Type:** Shows buttons for E-TM1.1, E-TM1.2, E-TM2, E-TM3.1, E-TM3.2, and E-TM3.3.
- System:** Shows buttons for LTE and LTE-Advanced.
- Test Type:** Shows buttons for BS Test and FRC(UL).
- Bandwidth:** Shows buttons for 1.4MHz, 3MHz, 5MHz, 10MHz, 15MHz, and 20MHz.
- Filter:** Shows buttons for None and Ideal.
- Data:** Shows Transport Block Size (2344 bit) and Data Type (PUSCH).
- Modulation:** Shows buttons for QPSK, 16QAM, and 64QAM.

The main screen displays the following parameters:

- System: LTE
- Test Type: BS Test/FRC(UL)
- FRC(UL): A1-1
- Bandwidth: 5MHz
- Cell ID: 0
- Roll Off Length: 0
- Ts Filter: Ideal
- Start Number of RB: 0
- nRNTI: 0
- hex: 0
- Modulation: QPSK
- UL-SCH: [checked]
- Group Hopping: Off
- Sequence Hopping: Off
- Delta ss: 0
- n(1)_DMRS: 0
- n(2)_DMRS: 0
- SRS: Off
- SRS Subframe: 0
- Package: LTE_FDD
- Export File Name: FRC_A1-1_05M
- Buttons: Calculation & Load, Calculation & Play

Easy Setup Screen (Example: FRC_UL)

• Normal Setup Screen

Detailed parameters are set at the Normal Setup screen to generate waveform patterns.

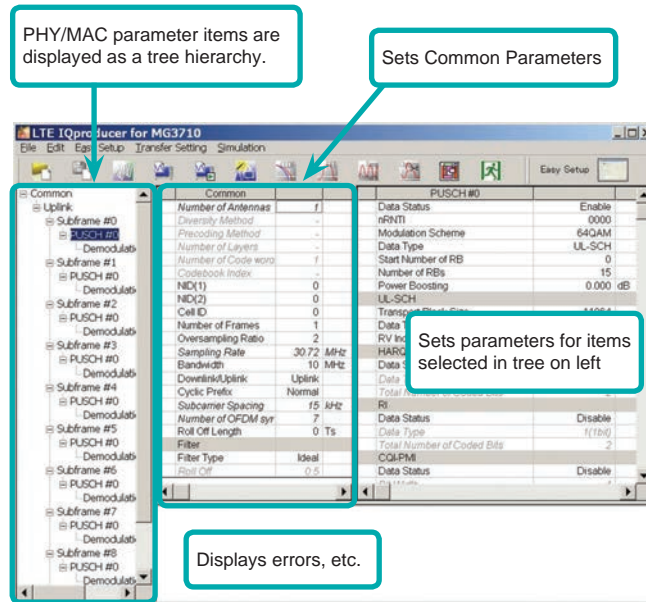

LTE IQproducer Setting Screen/Normal Setup Screen

• Easy Setup Menu

3GPP-defined test conditions can be selected from the Easy Setup menu tree to set values for the Normal Setup screen parameters.

BS Test/E-UTRA Test Models

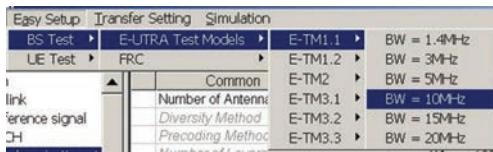

UE Test/RMC (DL)/FRC

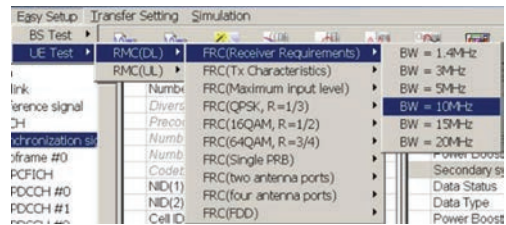

BS Test/FRC

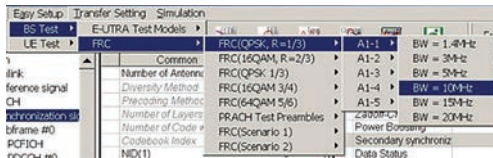

UE Test/RMC (UL)

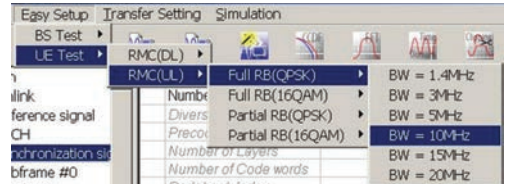

MX370108A LTE IQproducer MX370108A-001 LTE-Advanced FDD Option

Optional

MG3710A

- Visual Check on Frame Structure Screen

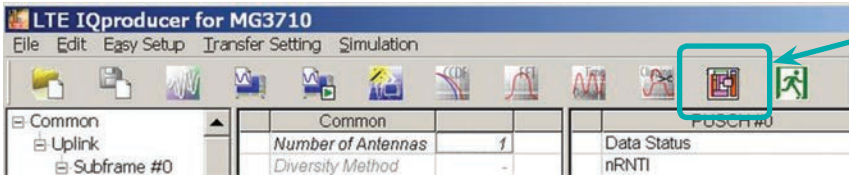

Displays Frame Structure screen for confirming channel allocation status and power of each OFDM Symbol

Power graph show/hide button

Full Scale button

Antenna Port select button

Display Resource Element allocation graphically with each channel color-coded.
Y-axis: Frequency (Resource Block units)
X-axis: Time (OFDM Symbol units)

Display power relative levels of OFDM Symbols with maximum power of 0 dB.
Y-axis: OFDM Symbol Power (dB)
X-axis: Time (OFDM Symbol units)

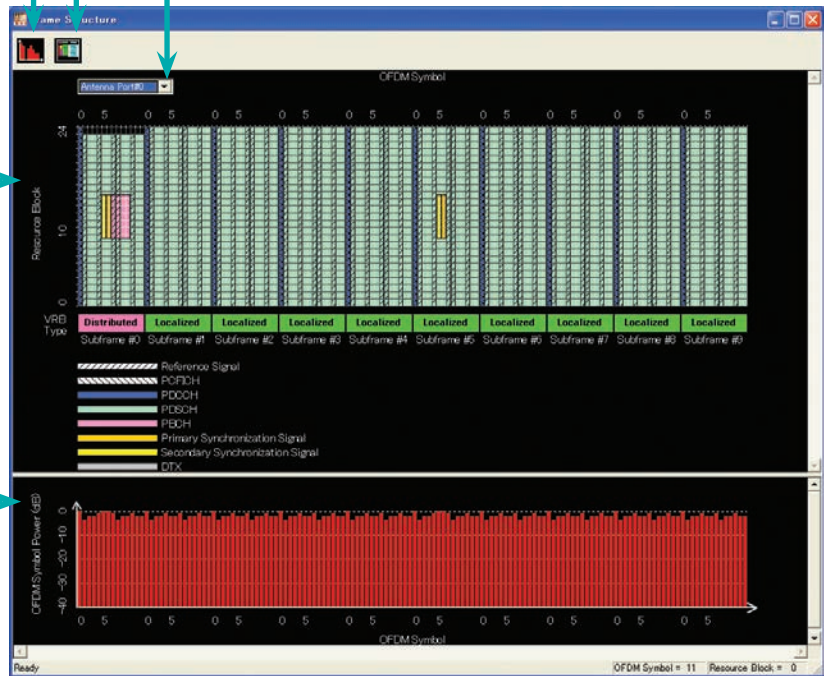

Frame Structure Screen (LTE)

MX370108A-001 LTE-Advanced FDD Option

Adding the MX370108A-001 LTE-Advanced FDD option to set LTE-Advanced system parameters supports generation of carrier aggregation signals added* by 3GPP Rel. 10.

Additionally, clustered SC-FDMA signals can be generated at Uplink.

*: MBSFN reference signals, UE-specific reference signals, Positioning reference signals, CSI reference signals, and Physical Multicast Channel are not supported.

• Easy Setup Screen

Waveform patterns can be generated easily by setting the band matching the carrier aggregation mode and component carrier because the main parameters are restricted to the Easy Setup screen.

Use the "Normal Setup Function" for detailed parameter settings.

LTE-Advanced Setting Parameters

Carrier Aggregation Mode

Intra-band
Component Carrier #0 to #4

Inter-band

Band #0, #1
Component Carrier #0 to #4

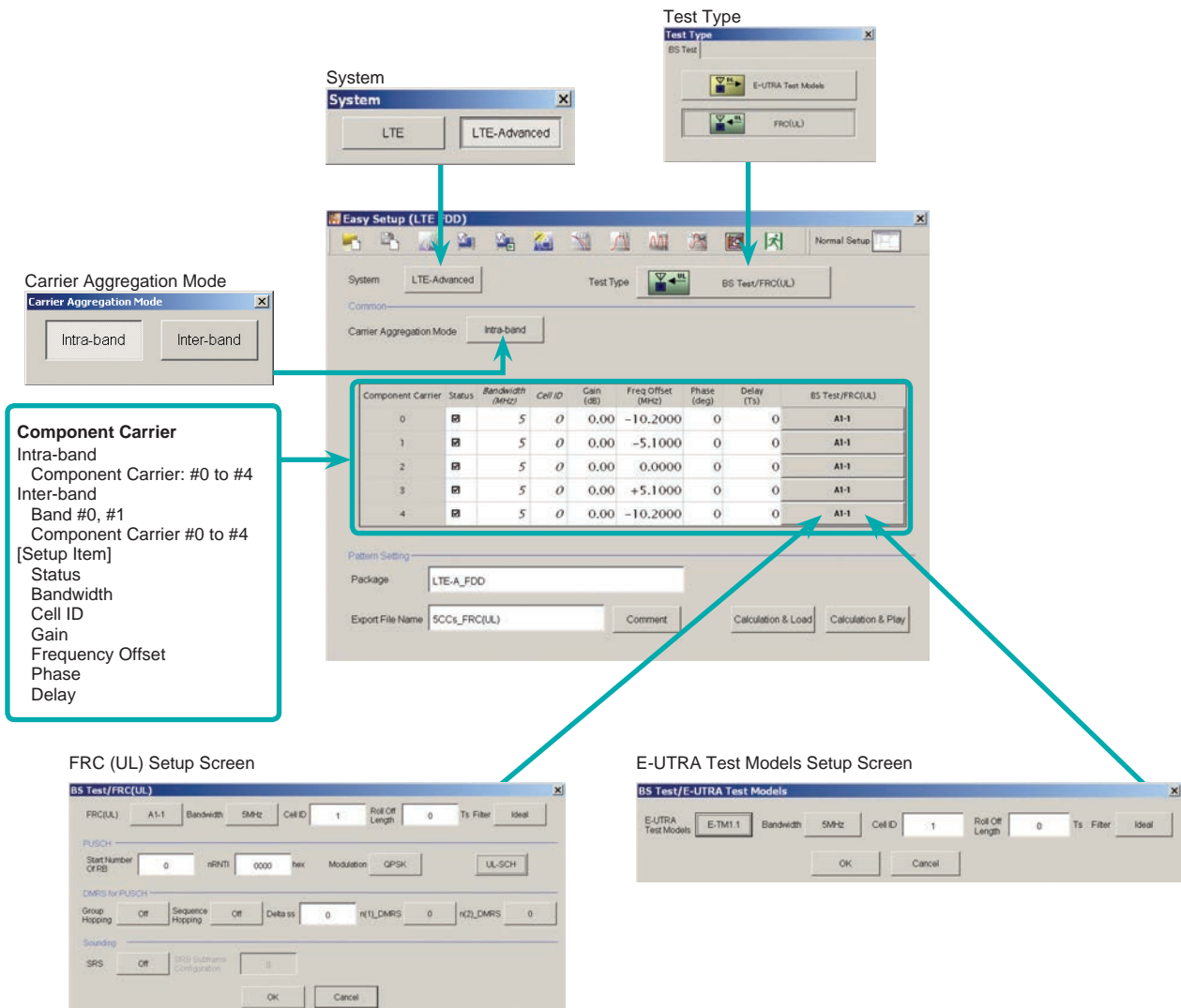

LTE-Advanced Easy Setup Screen (Example: FRC (UL) Test Models)

MX370108A LTE IQproducer MX370108A-001 LTE-Advanced FDD Option

Optional

MG3710A

• Normal Setup Screen

Detailed parameters are set at the Normal Setup screen to generate waveform patterns.

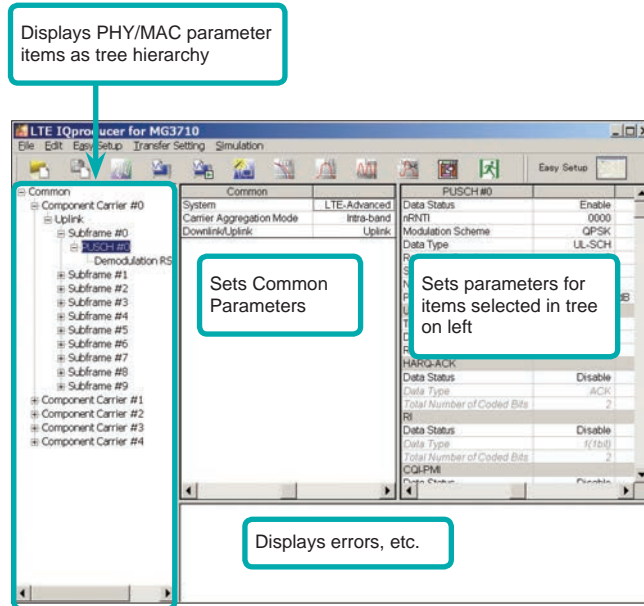

LTE-Advanced Setting Screen/Normal Setup Screen

• Easy Setup Menu

3GPP-defined test conditions can be selected from the Easy Setup menu tree to set values for the Normal Setup screen parameters.

Example: FRC Setup

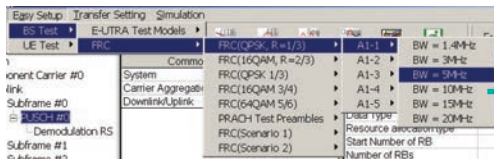

Simple operation by selecting target signals and component carriers as batch

Select Component Carrier Screen

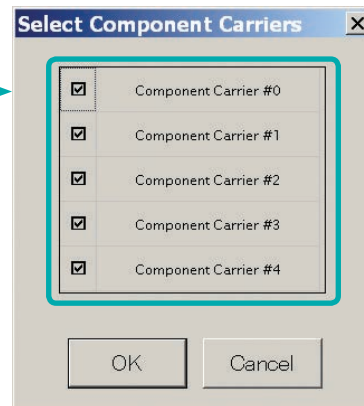

● MG3710A Vector Signal Generator –

One Unit Supports Carrier Aggregation Modes

The MG3710A supports an upper frequency limit of 6 GHz and an internal RF modulation bandwidth of 160 MHz*/120 MHz as well as up to two RF output connectors*2.

As a result, one unit supports LTE-Advanced carrier aggregation modes.

Calculation & Play Function*3

After waveform generation is completed, the generated pattern is loaded into memory, selected and output from the MG3710A.

When the Carrier Aggregation Mode is set to Inter-band, the Calculation & Play function can be used to load waveforms to each RF output (SG1/SG2) of the MG3710A in which two RF outputs are installed*2.

*1: Can generate and output signals for 160-MHz bandwidth max. wireless LAN (IEEE802.11ac) and for 120-MHz bandwidth.

*2: With MG3710A-062 (2.7 GHz)/064 (4 GHz)/066 (6 GHz) 2ndRF Option.

*3: This software is enabled only when used on the MG3710A.

The image shows two screenshots from the MG3710A software. The left screenshot is the 'Carrier Aggregation Mode Setup' screen, where 'Inter-band' is selected. A callout box points to the 'Carrier Aggregation Mode' dropdown and lists 'Band #0' and 'Band #1'. The right screenshot is the 'SG Setting' dialog, showing settings for SG1 and SG2. A callout box points to the 'Export File Name', 'Frequency', and 'Amplitude' fields for both SG1 and SG2, with a note: 'SG1/SG2 Setup • Frequency • Amplitude'. Another callout box points to the 'Calculation & Play' button, with a note: 'Simultaneously loads waveforms to two RF outputs (SG1/SG2)'. The main software window shows a table of component carriers and a 'Calculation & Play' button at the bottom right.

● Example of Vector Signal Generator Series LTE-Advanced Carrier Aggregation Function

Carrier Aggregation Mode	Vector Signal Generator Series		Vector Signal Generator Option for Signal Analyzer	
	MG3710A	MG3700A	MS2690A series Opt. 020*1	MS2830A Opt. 020/021*1
Intra-band contiguous Carrier Aggregation, Intra-band non-contiguous Carrier Aggregation	✓ (1 unit)	✓ (1 unit)	✓ (1 unit)	✓ (1 unit)
Inter-band non-contiguous Carrier Aggregation	✓ (2 RF 1 unit*2, or 1 RF 2 units)	✓ (2 units)	✓ (2 units)	✓ (2 units)

*1: MX269908A LTE IQproducer and MX269908A-001 LTE-Advanced FDD Option installed.

*2: MG3710A-062 (2.7 GHz)/064 (4 GHz)/066 (6 GHz) 2ndRF Option installed.

● Example: MG3710A Supports Carrier Aggregation

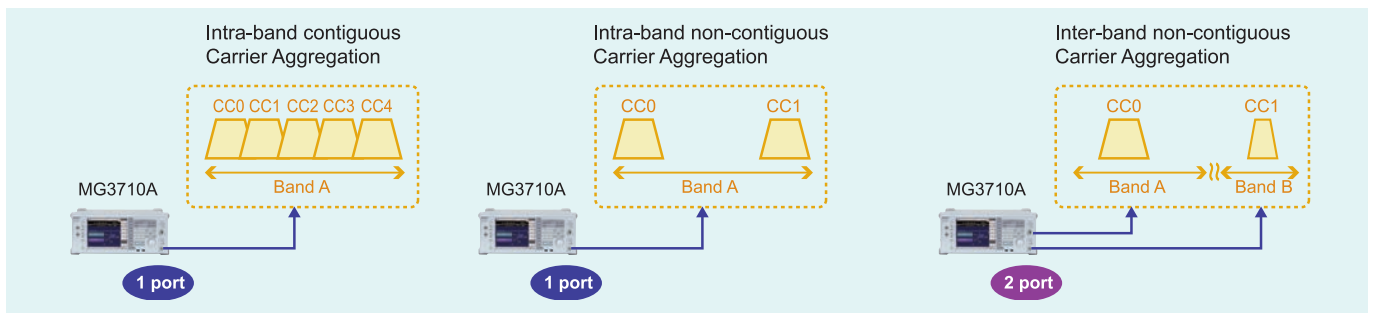

MX370108A LTE IQproducer MX370108A-001 LTE-Advanced FDD Option

Optional

MG3710A

- Visual Check on Frame Structure Screen

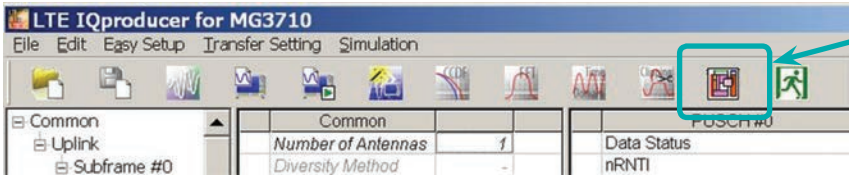

Displays Frame Structure screen for confirming channel allocation status and power of each OFDM Symbol

Power graph show/hide button

Full Scale button

Component Carrier select button

Band select button

Antenna Port select button

Display Resource Element allocation graphically with each channel color-coded.
Y-axis: Frequency (Resource Block units)
X-axis: Time (OFDM Symbol units)

Display power relative levels of OFDM Symbols with maximum power of 0 dB.
Y-axis: OFDM Symbol Power
X-axis: Time (OFDM Symbol units)



Frame Structure Screen (LTE-Advanced)

Easy Setup Screen (System = LTE)

● Test Type Setting Range

Display	Outline	Setting Range
Test Type	Sets the Test Type.	E-UTRA Test Models, FRC (UL)

● BS Test/E-UTRA Test Models Setting Range

Display	Outline	Setting Range
Common		
E-UTRA Test Models	Sets the E-UTRA Test Models.	E-TM1.1, E-TM1.2, E-TM2, E-TM2a, E-TM3.1, E-TM3.1a, E-TM3.2, E-TM3.3
Bandwidth	Sets the system bandwidth.	1.4, 3, 5, 10, 15, 20 MHz
Cell ID	Sets the Cell ID.	0 to 503
Filter	Sets filter.	Ideal, None

● BS Test/FRC (UL) Setting Range

Display	Outline	Setting Range
Common		
FRC (UL)	Selects the setting items described in 3GPP TS 36.141 Annex A and automatically sets the parameters.	A1-1, A1-2, A1-3, A1-4, A1-5, A2-1, A2-2, A2-3
Bandwidth	Sets the system bandwidth.	The settable bandwidth changes according to the selected FRC (UL).
Cell ID	Sets the Cell ID.	0 to 503
Roll Off Length	Sets the length of the ramp time applied to the OFDM symbol.	0 to 144
Filter	Sets the filter type.	Ideal, None
PUSCH		
Start Number of RB	Sets the start position of the RB to which the PUSCH is assigned.	Bandwidth = 1.4 MHz: 0 to (6-allocated resource block) Bandwidth = 3 MHz: 0 to (15-allocated resource block) Bandwidth = 5 MHz: 0 to (25-allocated resource block) Bandwidth = 10 MHz: 0 to (50-allocated resource block) Bandwidth = 15 MHz: 0 to (75-allocated resource block) Bandwidth = 20 MHz: 0 to (100-allocated resource block)
nRNTI	Sets the radio network temporary identifier.	0 to FFFF
Modulation	Sets the modulation mode.	QPSK, 16QAM, 64QAM
UL-SCH		
Transport Block Size	Sets the transport block size for UL-SCH.	0 to 86400
Data Type	Sets the Data type.	PN9fix, PN15fix, All0, All1
DMRS for PUSCH		
Group Hopping	Enables or disables group hopping.	Off, On
Sequence Hopping	Enables or disables Sequence Hopping.	Off, On
Delta ss	Sets Delta ss.	0 to 29
n(1)_DMRS	Sets the value used for automatic n_cs calculation.	0, 2, 3, 4, 6, 8, 9, 10
n(2)_DMRS	Sets the value used for automatic n_cs calculation.	0, 2, 3, 4, 6, 8, 9, 10
Sounding RS		
SRS	Enables or disables the Sounding RS parameter.	Off, On
SRS Subframe Configuration	Sets the SRS Subframe Configuration.	0 to 14

Easy Setup Screen (System = LTE-Advanced)

● Test Type Setting Range

Display	Outline	Setting Range
Test Type	Sets the Test Type	E-UTRA Test Models, FRC (UL)

● BS Test/E-UTRA Test Models Setting Range

Display	Outline	Setting Range
E-UTRA Test Models	Sets the E-UTRA Test Models	E-TM1.1, E-TM1.2, E-TM2, E-TM2a, E-TM3.1, E-TM3.1a, E-TM3.2, E-TM3.3
Bandwidth	Sets the system bandwidth	1.4, 3, 5, 10, 15, 20 MHz
Cell ID	Sets the Cell ID	0 to 503
Roll Off Length	Sets the length of the ramp time applied to the OFDM symbol	0 to 144
Filter	Sets filter	Ideal, None

● BS Test/FRC (UL) Setting Range

Display	Outline	Setting Range
Common		
FRC (UL)	Selects the setting items described in 3GPP TS 36.141 Annex A and automatically sets the parameters	A1-1, A1-2, A1-3, A1-4, A1-5, A2-1, A2-2, A2-3
Bandwidth	Sets the system bandwidth	The settable bandwidth changes according to the selected FRC (UL)
Cell ID	Sets the Cell ID	0 to 503
Roll Off Length	Sets the length of the ramp time applied to the OFDM symbol	0 to 144
Filter	Sets the filter type	Ideal, None

MX370108A LTE IQproducer

MX370108A-001 LTE-Advanced FDD Option

Optional

MG3710A

Display	Outline	Setting Range
PUSCH		
Start Number of RB	Sets the start position of the RB to which the PUSCH is assigned	Bandwidth = 1.4 MHz: 0 to (6-allocated resource block) Bandwidth = 3 MHz: 0 to (15-allocated resource block) Bandwidth = 5 MHz: 0 to (25-allocated resource block) Bandwidth = 10 MHz: 0 to (50-allocated resource block) Bandwidth = 15 MHz: 0 to (75-allocated resource block) Bandwidth = 20 MHz: 0 to (100-allocated resource block)
nRNTI	Sets the radio network temporary identifier	0 to FFFF
Modulation	Sets the modulation mode	QPSK, 16QAM, 64QAM
UL-SCH		
Transport Block Size	Sets the transport block size for UL-SCH	0 to 86400
Data Type	Sets the Data type	PN9fix, PN15fix, All0, All1
DMRS for PUSCH		
Group Hopping	Enables or disables group hopping	Off, On
Sequence Hopping	Enables or disables Sequence Hopping	Off, On
Delta ss	Sets Delta ss	0 to 29
n (1)_DMRS	Sets the value used for automatic n_cs calculation	0, 2, 3, 4, 6, 8, 9, 10
n (2)_DMRS	Sets the value used for automatic n_cs calculation	0, 2, 3, 4, 6, 8, 9, 10
Sounding RS		
SRS	Enables or disables the Sounding RS parameter	Off, On
SRS Subframe Configuration	Sets the SRS Subframe Configuration	0 to 14

Carrier Aggregation Mode Setting Range

Display	Outline	Setting Range														
Carrier Aggregation Mode	Sets the Carrier Aggregation Mode	Intra-band, Inter-band														
Parameter																
Component Carrier	Displays the Component Carrier number	Display only														
Status	Enables or disables the Component Carrier parameter	Check box selected, or cleared														
Bandwidth	Displays the system bandwidth for the Component Carrier	Display only														
Cell ID	Displays the cell ID for the Component Carrier	Display only														
Gain	Sets the level ratio of Component Carrier	-80.00 to 0.00 [dB]														
Freq.Offset	Sets the frequency offset	0 to $\pm (0.4 \times F_s - 0.5 \times \text{Band})$ [MHz] Band: Changed depending on the Component Carrier# transmission system bandwidth (Bandwidth) <table border="1" style="margin-left: auto; margin-right: auto;"> <thead> <tr> <th>Bandwidth [MHz]</th> <th>Band [MHz]</th> </tr> </thead> <tbody> <tr> <td>1.4</td> <td>1.095</td> </tr> <tr> <td>3.0</td> <td>2.715</td> </tr> <tr> <td>5.0</td> <td>4.515</td> </tr> <tr> <td>10.0</td> <td>9.015</td> </tr> <tr> <td>15.0</td> <td>13.515</td> </tr> <tr> <td>20.0</td> <td>18.015</td> </tr> </tbody> </table> Fs: 153.6 MHz (sampling rate)	Bandwidth [MHz]	Band [MHz]	1.4	1.095	3.0	2.715	5.0	4.515	10.0	9.015	15.0	13.515	20.0	18.015
Bandwidth [MHz]	Band [MHz]															
1.4	1.095															
3.0	2.715															
5.0	4.515															
10.0	9.015															
15.0	13.515															
20.0	18.015															
Phase	Sets the initial phase of the Component Carrier	0 to 359 [deg.]														
Delay	Sets delay of the Component Carrier	0 to 307200 [Ts]														
BS Test Type	Sets the details of BS Test Type of Component Carriers	BS Test/E-UTRA Test Models, BS Test/FRC(UL)														

Pattern Setting Setting Range

Display	Outline	Setting Range
Package	Enters waveform pattern package name	Up to 31 single-byte English alphanumeric characters
Export File Name	Enters waveform pattern file name	Carrier Aggregation Mode = Intra-band : Up to 18 single-byte English alphanumeric characters Carrier Aggregation Mode = Inter-band : Up to 15 single-byte English alphanumeric characters
Comment	Inputs comments to the waveform pattern	Up to 38 single-byte English alphanumeric characters \times 3 lines

Normal Setup Screen

Display	Outline	Setting Range
System	Switches 3GPP Systems	LTE, LTE-Advanced

● Common Parameter Setting Range (System = LTE)

Display	Outline	Setting Range
Common		
Number of Antennas	Sets number of antennas	1, 2, 4 (2 and 4 only at Downlink)
Diversity Method	Sets diversity method	Spatial Multiplexing, Tx Diversity
Precoding Method	Sets precoding method	Without CDD, Large-delay CDD, Large-delay CDD (Cyclic Precoder Index)
Number of Layers	Sets number of layers	1, 2, 3, 4
Number of Code words	Sets number of Code word	1, 2
Codebook index	Sets codebook index	When Number of Layers is 1: 0 to 3 When Number of Layers is 2: 0 to 2 When Number of Antennas is 4: 0 to 15
Physical-layer Cell-identity Group NID (1)	Sets physical-layer cell-identity group NID (1)	0 to 167
Physical-layer Identity NID (2)	Sets physical-layer identity NID (2)	0, 1, 2
Cell ID	Displays cell ID	0 to 503
Number of Frames	Sets number of frames	1 to max. number of frames in memory
Over Sampling Ratio	Sets over sampling ratio	2, 4
Sampling Rate	Displays sampling rate	Display only: Auto-setting using Over Sampling Ratio and bandwidth
Bandwidth	Sets system bandwidth	1.4, 3.0, 5, 10, 15, 20 MHz*
Downlink/Uplink	Sets downlink/uplink settings	Downlink, Uplink
Cyclic Prefix	Sets cyclic prefix	Normal, Extended
Subcarrier Spacing	Displays subcarrier spacing	Display only
Number of OFDM symbols per slot	Displays number of OFDM symbols per slot	7 (only when Cyclic Prefix = Normal), 6 (only when Cyclic Prefix = Extended)
Roll Off Length	Sets roll-off length for OFDM symbol	0 to 3152 Ts (when Random Access Preamble) 0 to 144 Ts (when Cyclic Prefix = Normal) 0 to 512 Ts (when Cyclic Prefix = Extended)
Filter		
Filter Type	Sets filter type	Nyquist, Root Nyquist, Ideal, None
Roll Off	Sets roll-off rate	0.1 to 1.0 (only enabled for Nyquist, Root Nyquist)

*: The 1.6 MHz and 3.2 MHz settings are not available for IQproducer Version 10.00 or later. In addition, parameter files for versions earlier than IQproducer Version 10.00 in which 1.6 MHz or 3.2 MHz is specified cannot be read.

● Common Parameter Setting Range (System = LTE-Advanced)

Display	Outline	Setting Range
Carrier Aggregation Mode	Sets the Carrier Aggregation Mode	Intra-band, Inter-band
Downlink/Uplink	Sets downlink or uplink	Downlink, Uplink

● PHY/MAC Parameter Setting Range (LTE-Advanced)

Display	Outline	Setting Range														
Carrier Aggregation																
Component Carrier	Displays the Component Carrier number	0 to 4														
Status	Enables or disables the Component Carrier parameter	Check box selected, or cleared														
Bandwidth	Displays the system bandwidth for the Component Carrier	Display only														
Cell ID	Displays the Cell ID for the Component Carrier	Display only														
Gain	Sets the level ratio of Component Carrier	-80.00 to 0.00 [dB]														
Freq.Offset	Sets the frequency offset	0 to ± (0.4 × Fs – 0.5 × Band) [MHz] Band: Changed depending on the Component Carrier transmission system bandwidth (Bandwidth) <table border="1" style="margin-left: auto; margin-right: auto;"> <thead> <tr> <th>Bandwidth [MHz]</th> <th>Band [MHz]</th> </tr> </thead> <tbody> <tr> <td>1.4</td> <td>1.095</td> </tr> <tr> <td>3.0</td> <td>2.715</td> </tr> <tr> <td>5.0</td> <td>4.515</td> </tr> <tr> <td>10.0</td> <td>9.015</td> </tr> <tr> <td>15.0</td> <td>13.515</td> </tr> <tr> <td>20.0</td> <td>18.015</td> </tr> </tbody> </table> Fs: 153.6 MHz (sampling rate)	Bandwidth [MHz]	Band [MHz]	1.4	1.095	3.0	2.715	5.0	4.515	10.0	9.015	15.0	13.515	20.0	18.015
Bandwidth [MHz]	Band [MHz]															
1.4	1.095															
3.0	2.715															
5.0	4.515															
10.0	9.015															
15.0	13.515															
20.0	18.015															
Phase	Sets the initial phase of the Component Carrier	0 to 359 [deg.]														
Delay	Sets delay of the Component Carrier	0 to 307200 [Ts]														
Component Carrier																
Number of Antennas	Sets the number of antennas	1, 2, 4														
Diversity Method	Sets the diversity method	Spatial Multiplexing, Tx Diversity														
Precoding Method	Sets the precoding method	Without CDD, Large-delay CDD, Large-delay CDD (Cyclic Precoder Index)														
Number of Layers	Sets the number of layers	1, 2, 3, 4														
Number of Code words	Sets the number of code words	1, 2														

MX370108A LTE IQproducer

MX370108A-001 LTE-Advanced FDD Option

Optional

MG3710A

Display	Outline	Setting Range
Codebook index	Sets the codebook index	When Number of Antennas is 2, the setting range varies according to Number of Layers as follows When Number of Layers is 1: 0 to 3 When Number of Layers is 2: 0 to 2 When Number of Layers is 4: 0 to 15
NID (1)	Sets the NID (1)	0 to 167
NID (2)	Sets the NID (2)	0, 1, 2
Cell ID	Sets the Cell ID	0 to 503
Number of Frames	Sets the number of frames to be generated	1 to the maximum number of frames that can be stored in the main unit's waveform memory
Over Sampling Ratio	Sets the oversampling ratio	1, 2, 4
Sampling Rate	Displays the sampling rate	Display only: automatically set according to the Oversampling Ratio and Bandwidth values
Bandwidth	Sets the system bandwidth	1.4, 3, 5, 10, 15, 20 MHz
Cyclic Prefix	Sets the cyclic prefix	Normal, Extended
Subcarrier Spacing	Displays the subcarrier spacing (interval)	Display only
Number of OFDM symbols per slot	Sets the number of OFDM symbols per slot	Display only
Roll Off Length	Sets the length of the ramp time applied to the OFDM symbol	0 to 3152 Ts (Random Access Preamble) 0 to 144 Ts (Cyclic prefix = Normal) 0 to 512 Ts (Cyclic prefix = Extended)
Filter		
Filter Type	Sets the filter type	Nyquist, Root Nyquist, Ideal, None
Roll Off	Sets the roll-off factor	0.1 to 1.0

● PHY/MAC Parameter (Downlink) Setting Range

Display	Outline	Setting Range
Downlink		
PHICH	Sets ON/OFF for PHICH	ON, OFF
PHICH duration	Sets the PHICH area	Normal, Extended
Ng	Sets the parameter (Ng) for determining the PHICH arrangement	1/6, 1/2, 1, 2
Reference Signal		
Reference Signal Sequence	Sets data used as reference signal sequence	Gold Sequence, PN9fix, PN15fix, 16bit repeat, User File
Reference Signal Sequence Repeat Data	Sets 16bit repeat data installed in reference signal sequence	0000 to FFFF (only when reference signal sequence = 16bit repeat)
Reference Signal Sequence User File	Sets user file installed in reference signal sequence	Select any file (only when reference signal sequence = User File)
Frequency Shift Value	Displays frequency shift	0, 1, 2, 3, 4, 5
Power Boosting	Sets power boosting	-20.000 to +20.000 dB
PBCH		
Data Status	Enables/disables PBCH parameter	Disable, Enable
Data Type	Sets data type	PN9fix, PN15fix, 16bit repeat, User File, BCH
Data Type Repeat Data	Sets 16bit repeat data	0000 to FFFF (only when Data Type = 16bit repeat)
Data Type User File	Sets user file	Select any file (only when Data Type = User File)
Power Boosting	Sets power boosting	-20.000 to +20.000 dB
BCH		
Data Type	Sets data type	PN9fix, PN15fix, 16bit repeat, User File, BCCH
Data Type Repeat Data	Sets 16bit repeat data installed in BCH	0000 to FFFF (only when Data Type = 16bit repeat)
Data Type User File	Sets user file to install in BCH	Select any file (only when Data Type = User File)
Transport Block Size	Sets number of bits required for BCH	When Cyclic Prefix = Normal, Max. 1920 When Cyclic Prefix = Extended, Max. 1728
DL Bandwidth	Displays data mapped to BCCH	n6, n15, n25, n50, n75, n100
PHICH duration	Displays the PHICH duration mapped to BCCH	Normal, Extended
Ng	Displays the Ng value mapped to BCCH	1/6, 1/2, 1, 2
SFN Offset	Sets the initial SFN value mapped to BCCH	0 to 1023
Synchronization Signals		
Primary Synchronization Signal		
Data Status	Enables/disables primary synchronization signal parameter	Disable, Enable
Data Type	Sets data type	Zadoff-Chu Sequence, User File
Data Type User File	Sets user file to install in primary synchronization signal	Select any file (only when Data Type = User File)
Zadoff-Chu Sequence index u	Displays Zadoff-Chu Sequence index u	25, 29, 34
Power Boosting	Sets power boosting	-20.000 to +20.000 dB
Secondary Synchronization Signal		
Data Status	Enables/disables secondary synchronization signal parameter	Disable, Enable
Data Type	Sets data type	Concatenated sequence, PN9fix, PN15fix, 16bit repeat, User File
Data Type Repeat Data	Sets 16bit repeat data	0000 to FFFF (only when Data Type = 16bit repeat)
Data Type User File	Sets user file	Select any file (only when Data Type = User File)
Power Boosting	Sets power boosting	-20.000 to +20.000 dB

MX370108A LTE IQproducer MX370108A-001 LTE-Advanced FDD Option

Optional

MG3710A

Display	Outline	Setting Range
Subframe#0 to #9		
Virtual Resource Block type	Sets the Virtual Resource Block	Localized, Distributed
Gap	Sets Gap	1st Gap, 2nd Gap
Gap value	Sets Gap value	3 to 48
Number of VRBs	Displays the number of VRB	6 to 96
Number of PHICH Groups	Sets PHICH Groups in one subframe	Display only (determined by the combination of Bandwidth, Ng, and Cyclic Prefix. It is fixed to 0 when PHICH is Off.)
Number of OFDM symbols for PDCCH	Sets number of OFDM symbols for PDCCH	1 to 4
Total Number of CCEs	Display Total Number of CCE	Display only
Number of PDCCHs	Sets number of PDCCHs	1 to 64
CCE arrangement	Sets CCE arrangement	PDCCH#0 to (Number of PDCCHs – 1), dummy
Number of PDSCHs	Sets number of PDSCHs	1 to 64
RB arrangement	Sets RB arrangement	PDSCH#0 to Number of PDSCHs – 1
VRB arrangement	Sets the VRB arrangement	PDSCH#0 to (Number of VRBs – 1)
PCFICH		
Data Status	Enables/disables PCFICH parameter	Disable, Enable
Data Type	Sets data type	CFI codeword, PN9fix, PN15fix, 16bit repeat, User File
CFI	Sets CFI codeword type	1, 2, 3
Data Type Repeat Data	Sets 16bit repeat data	0000 to FFFF (only when Data Type = 16bit repeat)
Data Type User File	Sets user file	Select any file (only when Data Type = User File)
Power Boosting	Sets power boosting	–20.000 to +20.000 dB
PDCCH		
Data Status	Enables/disables PDCCH Parameter	Disable, Enable
PDCCH format	Sets PDCCH format	0, 1, 2, 3
Data Type	Sets data type	PN9fix, PN15fix, 16bit repeat, User File, DCI
Data Type Repeat Data	Sets 16bit repeat data	0000 to FFFF (only when Data Type = 16bit repeat)
Data Type User File	Sets user file	Select any file (only when Data Type = User File)
Power Boosting	Sets power boosting	–20.000 to +20.000 dB
DCI		
Data Type	Sets data type	PN9fix, PN15fix, 16bit repeat, User File
Data Type Repeat Data	Sets 16bit repeat data	0000 to FFFF (only when Data Type = 16bit repeat)
Data Type User File	Sets user file	Select any file (only when Data Type = User File)
Transport Block Size	Sets number of bits required for DCI	0 to 576
nRNTI	Sets Radio network temporary identifier	0000 to FFFF
PDSCH		
Data Status	Enables/disables PDSCH parameter	Disable, Enable
nRNTI	Sets Radio network temporary identifier	0000 to FFFF
Modulation Scheme	Sets modulation scheme	QPSK, 16QAM, 64QAM, 256QAM
Data Type	Sets data type	PN9fix, PN15fix, 16bit repeat, User File, DL-SCH
Data Type Repeat Data	Sets 16bit repeat data	0000 to FFFF (only when Data Type = 16bit repeat)
Data Type User File	Sets user file	Select any file (only when Data Type = User File)
Power Boosting	Sets power boosting	–20.000 to +20.000 dB
DL-SCH		
Data Type	Sets data type	PN9fix, PN15fix, 16bit repeat, User File
Data Type Repeat Data	Sets 16bit repeat data	0000 to FFFF (only when Data Type = 16bit repeat)
Data Type User File	Sets user file	Select any file (only when Data Type = User File)
Transport Block Size	Sets number of bits required for DL-SCH	Changes max. value of setting range by number of Resource Blocks and the modulation scheme
UE Category	Sets UE Category	1, 2, 3, 4, 5
RV Index	Sets redundancy version index	0, 1, 2, 3
PHICH		
Data Status	Enable/disables PHICH parameter	Disable, Enable
PHICH Group number	Display PHICH Group number	Display only
Number of PHICHs	Sets Number of PHICHs	1 to 8 (Cyclic Prefix = Normal) 1 to 4 (Cyclic Prefix = Extended)
Power Boosting	Set power boosting	Display only
PHICH#0 to # (Number of PHICHs–1)		
Data Status	Enable/disable PHICH parameter	Disable, Enable
Orthogonal Sequence Index	Sets orthogonal sequence index	0 to 7 (When Cyclic Prefix = Normal) 0 to 3 (When Cyclic Prefix = Extended)
Data Type	Display data type	Display only: HI codeword
HI	Sets code word of HI (HARQ indicator)	000, 111
Power Boosting	Set power boosting	–20.000 to +20.000 dB

MX370108A LTE IQproducer

MX370108A-001 LTE-Advanced FDD Option

Optional

MG3710A

● PHY/MAC Parameter (Uplink) Setting Range

Display	Outline	Setting Range
Uplink		
Data Transmission/Random Access Preamble	Selects Data Transmission or Random Access Preamble	Data Transmission/Random Access Preamble
DMRS Parameters	Sets the calculation method of Demodulation RS parameter.	Auto, Manual
PUCCH Parameters		
delta PUCCH shift	Sets delta PUCCH shift	1, 2, 3
N_CS(1)	Sets the value of N_CS(1), which is the number of cyclic shifts used in the PUCCH formats 1, 1a, and 1b	0 to 7
N_RB(2)	Sets the value of N_RB(2), which is the number of resource blocks used in the PUCCH formats 2, 2a, and 2b	0 to 63
Sounding RS Parameters		
SRS	Sets SRS ON/OFF	ON, OFF
SRS Subframe Configuration	Sets the SRS Subframe Configuration	0 to 14
Subframe#0 to #9 (Data Transmission)		
Number of PUCCHs	Sets number of PUCCH	0, 1, 2, 3, 4, 5, 6, 7, 8
Number of PUSCHs	Sets number of PUSCH	0, 1, 2, 3, 4, 5, 6, 7, 8
PUCCH#0 to #7		
Data Status	Enables/disables PUCCH parameter	Disable, Enable
n(1)_PUCCH	Sets the resource number for PUCCH 1, 1a, and 1b	0 to 764
n(2)_PUCCH	Sets the resource number for PUCCH 2, 2a, and 2b	0 to 764
nRNTI	Sets Radio network temporary identifier	0000 to FFFF
PUCCH format	Sets PUCCH format	1, 1a, 1b, 2, 2a, 2b
Data Type	Sets data type	PN9fix, PN15fix, 16bit repeat, User File, UCI
Data Type Repeat Data	Sets 16bit repeat data	0000 to FFFF (only when Data Type = 16bit repeat)
Data Type User File	Sets user file	Select any file (only when Data Type = User File)
Group Hopping	Enables or disables group hopping	Disable, Enable
Base Sequence Group Number u	Sets base sequence group number	0 to 29
Base Sequence Number v	Displays base sequence number	0 fixed
Power Boosting	Sets power boosting	-20.000 to +20.000 dB
UCI		
Transport Block Size	Sets transport block size of UCI	1 (When PUCCH format = 1a) 2 (When PUCCH format = 1b) 1 to 13 (When PUCCH format = 2) 2 to 14 (When PUCCH format = 2a) 3 to 15 (When PUCCH format = 2b)
Data Type	Sets data type	PN9fix, PN15fix, 16bit repeat, User File
Data Type Repeat Data	Sets 16bit repeat data	0000 to FFFF (only when Data Type = 16bit repeat)
Data Type User File	Sets user file	Select any file (only when Data Type = User File)
Demodulation RS for PUCCH		
Data Type	Sets data type	Base Sequence, User File
Data Type User File	Sets user file	Select any file (only when Data Type = User File)
Group Hopping	Enable/disable Group Hopping parameter	Disable, Enable
Base Sequence Group Number u	Sets base sequence group number	0 to 29
Base Sequence Number v	Displays base sequence group number	0 fixed
PUSCH#0 to #7		
Data Status	Enables/disables PUSCH parameter	Disable, Enable
nRNTI	Sets Radio network temporary identifier	0000 to FFFF
Modulation Scheme	Sets modulation system	QPSK, 16QAM, 64QAM
Data Type	Sets data type	PN9fix, PN15fix, 16bit repeat, User File, UL-SCH
Data Type Repeat Data	Sets 16bit repeat data	0000 to FFFF (only when Data Type = 16bit repeat)
Data Type User File	Sets user file	Select any file (only when Data Type = User File)
Resource allocation type	Sets the Resource allocation type	type0, type1 When type1 is selected, Start Number of RB and Number of RBs cannot be set
Start Number of RB	Start position of RB	When Bandwidth is 1.4 MHz: 0 to 5 When Bandwidth is 3 MHz: 0 to 14 When Bandwidth is 5 MHz: 0 to 24 When Bandwidth is 10 MHz: 0 to 49 When Bandwidth is 15 MHz: 0 to 74 When Bandwidth is 20 MHz: 0 to 99
Number of RBs	Total number of RB	When Bandwidth is 1.4 MHz: 1 to 6 When Bandwidth is 3 MHz: 1 to 15 When Bandwidth is 5 MHz: 1 to 25 When Bandwidth is 10 MHz: 1 to 50 When Bandwidth is 15 MHz: 1 to 75 When Bandwidth is 20 MHz: 1 to 100

MX370108A LTE IQproducer MX370108A-001 LTE-Advanced FDD Option

Optional

MG3710A

Display	Outline	Setting Range																					
Start Number of RBG for 1st	Sets the start position of the RBG for 1st	<p>The setting range varies depending on the Bandwidth setting as follows</p> <table border="1" style="margin-left: auto; margin-right: auto;"> <thead> <tr style="background-color: #D9E1F2;"> <th>Bandwidth (Number of RBs)</th> <th>Setting range*</th> </tr> </thead> <tbody> <tr><td>1.4 MHz (6)</td><td>1 to 4</td></tr> <tr><td>3 MHz (15)</td><td>1 to 6</td></tr> <tr><td>5 MHz (25)</td><td>1 to 11</td></tr> <tr><td>10 MHz (50)</td><td>1 to 15</td></tr> <tr><td>15 MHz (75)</td><td>1 to 17</td></tr> <tr><td>20 MHz (100)</td><td>1 to 23</td></tr> </tbody> </table> <p>*: The maximum value of the setting range is smaller than End Number of RBG for 1st + 1</p>	Bandwidth (Number of RBs)	Setting range*	1.4 MHz (6)	1 to 4	3 MHz (15)	1 to 6	5 MHz (25)	1 to 11	10 MHz (50)	1 to 15	15 MHz (75)	1 to 17	20 MHz (100)	1 to 23							
Bandwidth (Number of RBs)	Setting range*																						
1.4 MHz (6)	1 to 4																						
3 MHz (15)	1 to 6																						
5 MHz (25)	1 to 11																						
10 MHz (50)	1 to 15																						
15 MHz (75)	1 to 17																						
20 MHz (100)	1 to 23																						
End Number of RBG for 1st	Sets the end position of the RBG for 1st	<p>The setting range varies depending on the Bandwidth setting as follows</p> <table border="1" style="margin-left: auto; margin-right: auto;"> <thead> <tr style="background-color: #D9E1F2;"> <th>Bandwidth (Number of RBs)</th> <th>Setting range*</th> <th>Default</th> </tr> </thead> <tbody> <tr><td>1.4 MHz (6)</td><td>1 to 4</td><td>3</td></tr> <tr><td>3 MHz (15)</td><td>1 to 6</td><td>3</td></tr> <tr><td>5 MHz (25)</td><td>1 to 11</td><td>6</td></tr> <tr><td>10 MHz (50)</td><td>1 to 15</td><td>8</td></tr> <tr><td>15 MHz (75)</td><td>1 to 17</td><td>8</td></tr> <tr><td>20 MHz (100)</td><td>1 to 23</td><td>12</td></tr> </tbody> </table> <p>*: The maximum value of the setting range is smaller than End Number of RBG for 1st + 1</p>	Bandwidth (Number of RBs)	Setting range*	Default	1.4 MHz (6)	1 to 4	3	3 MHz (15)	1 to 6	3	5 MHz (25)	1 to 11	6	10 MHz (50)	1 to 15	8	15 MHz (75)	1 to 17	8	20 MHz (100)	1 to 23	12
Bandwidth (Number of RBs)	Setting range*	Default																					
1.4 MHz (6)	1 to 4	3																					
3 MHz (15)	1 to 6	3																					
5 MHz (25)	1 to 11	6																					
10 MHz (50)	1 to 15	8																					
15 MHz (75)	1 to 17	8																					
20 MHz (100)	1 to 23	12																					
Start Number of RBG for 2nd	Sets the start position of the RBG for 2nd	<p>The setting range varies depending on the Bandwidth setting as follows</p> <table border="1" style="margin-left: auto; margin-right: auto;"> <thead> <tr style="background-color: #D9E1F2;"> <th>Bandwidth (Number of RBs)</th> <th>Setting range*</th> <th>Default</th> </tr> </thead> <tbody> <tr><td>1.4 MHz (6)</td><td>3 to 6</td><td>5</td></tr> <tr><td>3 MHz (15)</td><td>3 to 8</td><td>5</td></tr> <tr><td>5 MHz (25)</td><td>3 to 13</td><td>8</td></tr> <tr><td>10 MHz (50)</td><td>3 to 17</td><td>10</td></tr> <tr><td>15 MHz (75)</td><td>3 to 19</td><td>10</td></tr> <tr><td>20 MHz (100)</td><td>3 to 25</td><td>14</td></tr> </tbody> </table> <p>*: The maximum value of the setting range is smaller than End Number of RBG for 1st + 1</p>	Bandwidth (Number of RBs)	Setting range*	Default	1.4 MHz (6)	3 to 6	5	3 MHz (15)	3 to 8	5	5 MHz (25)	3 to 13	8	10 MHz (50)	3 to 17	10	15 MHz (75)	3 to 19	10	20 MHz (100)	3 to 25	14
Bandwidth (Number of RBs)	Setting range*	Default																					
1.4 MHz (6)	3 to 6	5																					
3 MHz (15)	3 to 8	5																					
5 MHz (25)	3 to 13	8																					
10 MHz (50)	3 to 17	10																					
15 MHz (75)	3 to 19	10																					
20 MHz (100)	3 to 25	14																					
End Number of RBG for 2nd	Sets the end position of the RBG for 2nd	<p>The setting range varies depending on the Bandwidth setting as follows</p> <table border="1" style="margin-left: auto; margin-right: auto;"> <thead> <tr style="background-color: #D9E1F2;"> <th>Bandwidth (Number of RBs)</th> <th>Setting range</th> <th>Default</th> </tr> </thead> <tbody> <tr><td>1.4 MHz (6)</td><td>3 to 6</td><td>6</td></tr> <tr><td>3 MHz (15)</td><td>3 to 8</td><td>8</td></tr> <tr><td>5 MHz (25)</td><td>3 to 13</td><td>13</td></tr> <tr><td>10 MHz (50)</td><td>3 to 17</td><td>17</td></tr> <tr><td>15 MHz (75)</td><td>3 to 19</td><td>19</td></tr> <tr><td>20 MHz (100)</td><td>3 to 25</td><td>25</td></tr> </tbody> </table>	Bandwidth (Number of RBs)	Setting range	Default	1.4 MHz (6)	3 to 6	6	3 MHz (15)	3 to 8	8	5 MHz (25)	3 to 13	13	10 MHz (50)	3 to 17	17	15 MHz (75)	3 to 19	19	20 MHz (100)	3 to 25	25
Bandwidth (Number of RBs)	Setting range	Default																					
1.4 MHz (6)	3 to 6	6																					
3 MHz (15)	3 to 8	8																					
5 MHz (25)	3 to 13	13																					
10 MHz (50)	3 to 17	17																					
15 MHz (75)	3 to 19	19																					
20 MHz (100)	3 to 25	25																					
Power Boosting	Sets power boosting	-20.000 to +20.000 dB																					
UL-SCH																							
Transport Block Size	Sets transport block size of UL-SCH	Changes max. value of the setting range by number of Resource Blocks																					
Data Type	Sets mapping data type	PN9fix, PN15fix, 16bit repeat, User File																					
Data Type Repeat Data	Sets 16bit repeat data	0000 to FFFF (only when Data Type = 16bit repeat)																					
Data Type User File	Sets user file	Select any file (only when Data Type = User File)																					
RV Index	Sets redundancy version index	0, 1, 2, 3																					
HARQ-ACK																							
Data Status	This enables or disables HARQ-ACK	Disable, Enable																					
Data Type	Sets the Data type to be inserted into the HARQ-ACK	ACK, NACK, ACK-ACK, ACK-NACK, NACK-ACK, NACK-NACK																					
Total Number of Coded Bits	Sets the number of bits after HARQ-ACK encoding	0 to Number of RBs × 288																					
RI																							
Data Status	Enables or disables the RI	Disable, Enable																					
Data Type	Sets the Data type to be inserted into the RI	1 (1 bit), 2 (1 bit), 1 (2 bits), 2 (2 bits), 3 (2 bits), 4 (2 bits)																					
Total Number of Coded Bits	Sets the number of bits after RI encoding	0 to Number of RBs × 288																					
CQI/PMI																							
Data Status	Enables or disables the CQI/PMI	Disable, Enable																					
Data Type	Sets the Data type to be inserted into the CQI/PMI	PN9fix, PN15fix, 16bit repeat, User File																					
Data Type Repeat Data	Sets the 16bit repeat data to be inserted into the CQI/PMI	0000 to FFFF (only when Data Type = 16bit repeat)																					
Data Type User File	Sets the User type to be inserted into the CQI/PMI	Select any file (only when Data Type = User File)																					
Total Number of Coded Bits	Sets the number of bits after CQI/PMI encoding	0 to 86400																					

MX370108A LTE IQproducer

MX370108A-001 LTE-Advanced FDD Option

Optional

MG3710A

Display	Outline	Setting Range
Demodulation RS for PUSCH		
Data Type	Sets data installed in demodulation RS for PUSCH	Base Sequence, User File
Data Type User File	Sets user file	Select any file (only when Data Type = User File)
Group Hopping	Enable/disable Group Hopping parameter	Disable, Enable (only when Data Type = Base Sequence)
Sequence Hopping	Enables or disables Sequence Hopping	Disable, Enable
Delta ss	Sets Delta ss	0 to 29 (only when Data Type = Base Sequence)
Base Sequence Group Number u	Sets base sequence group number	0 to 29 (only when Data Type = Base Sequence)
Base Sequence Number v	Displays base sequence number	0, 1
Cyclic Shift		
n_cs Setting	Sets the Auto/Manual switching of n_cs setting	Auto, Manual
n(1)_DMRS	Sets the value used for automatic n_cs calculation	0, 2, 3, 4, 6, 8, 9, 10
n(2)_DMRS	Sets the value used for automatic n_cs calculation	0, 2, 3, 4, 6, 8, 9, 10
Cyclic Shift 1st slot		
n_cs	Sets n_cs for the first slot of Demodulation RS	0 to 11
alpha	Displays the cyclic shift of the first slot of Demodulation RS	The alpha value is calculated using the following equation, and the result is displayed to the 5th decimal point. $\alpha = 2\pi \times n_cs / 12$
Cyclic Shift 2nd slot		
n_cs	Sets n_cs for the second slot of Demodulation RS	0 to 11
alpha	Displays the cyclic shift of the second slot of Demodulation RS	The alpha value is calculated using the following equation, and the result is displayed to the 5th decimal point. $\alpha = 2\pi \times n_cs / 12$
Sounding RS		
Data Status	This enables or disables the Sounding RS parameter	Enable, Disable
Data Type	Sets the data to insert into Sounding RS	Base Sequence, User File
Data Type User File	This sets the user file to be inserted into Sounding RS	Select any file (only when Data Type = User File)
Group Hopping	Enables or disables group hopping	Disable, Enable (only when Data Type = Base Sequence)
Sequence Hopping	Enables or disables Sequence Hopping	Disable, Enable
Delta ss	Sets Delta ss	0 to 29
Base Sequence Group Number u	Sets the base sequence group number	0 to 29 (only when Data Type = Base Sequence)
Base Sequence Number v	Sets the base sequence number	0, 1 (only when Data Type = Base Sequence)
SRS Bandwidth Configuration	Sets SRS Bandwidth Configuration	0 to 7
SRS Bandwidth	Sets SRS Bandwidth	0 to 3
k_TC	Sets Transmission Comb	0, 1
SRS Hopping Bandwidth	Sets SRS Hopping Bandwidth	3 fixed
n_RRC	Sets Frequency Domain Position	0 to 23
Power Boosting	Sets the transmission power	-20.000 to +20.000 dB
Cyclic Shift		
n_SRS	Sets n_SRS	0 to 7
alpha	Displays Cyclic Shift	The alpha value is calculated using the following equation, and the result is displayed to the 5th decimal point. $\alpha = 2\pi \times n_SRS / 8$
Random Access Preamble		
PRACH Configuration	Sets transmission timing of PRACH	0 to 63 (Except 30, 46, 60, 61, 62)
Preamble Format	Displays preamble format	Display only
Data Type	Sets data type	Root Zadoff-Chu Sequence, User File
Data Type User File	Sets user file	Select any file (only when Data Type = User File)
Root Zadoff-Chu Sequence	Sets Root Zadoff-Chu Sequence	1 to 839 (only when Data Type = Root Zadoff-Chu Sequence)
Cyclic Shift Value	Sets cyclic shift value	0 to 838 (only when Data Type = Root Zadoff-Chu Sequence)
Random Access Preamble Length	Displays length for random access preamble	Display only
Hopping Pattern Length	Sets frequency hopping pattern	1 to 10 frames
Hopping Pattern	Sets frequency hopping pattern for random access preamble in RB units	0 to 94, OFF
Power Ramping Step Size	Sets power increase step at each random access preamble transmission	0.0 to 10.0 dB

● Easy Setup Parameter Setting Range

Display	Setting Range
BS Test	
E-UTRA Test Models	E-TM1.1, E-TM1.2, E-TM2, E-TM2a, E-TM3.1, E-TM3.1a, E-TM3.2, E-TM3.3
FRC	FRC (QPSK, R = 1/3): A1-1, A1-2, A1-3, A1-4, A1-5 FRC (16QAM, R = 2/3): A2-1, A2-2, A2-3 FRC (QPSK 1/3): A3-1, A3-2, A3-3, A3-4, A3-5, A3-6, A3-7 FRC (16QAM 3/4): A4-1, A4-2, A4-3, A4-4, A4-5, A4-6, A4-7, A4-8 FRC (64QAM 5/6): A5-1, A5-2, A5-3, A5-4, A5-5, A5-6, A5-7 PRACH Test Preambles: A6-1 (Burst format0, 1, 2, 3), A6-2 (Burst format0, 1, 2, 3) FRC (Scenario 1): A7-1, A7-1 (SRS Option), A7-2, A7-2 (SRS Option), A7-3, A7-3 (SRS Option), A7-4, A7-4 (SRS Option), A7-5, A7-5 (SRS Option), A7-6, A7-6 (SRS Option) FRC (Scenario 2): A8-1, A8-1 (SRS Option), A8-2, A8-2 (SRS Option), A8-3, A8-3 (SRS Option), A8-4, A8-4 (SRS Option), A8-5, A8-5 (SRS Option), A8-6, A8-6 (SRS Option)
UE Test	
RMC (DL)	FRC (Receiver Requirements) FRC (Maximum input level): Category 1, Category 2, Category 3-5 FRC (Tx Characteristics) FRC (QPSK, R = 1/3): R.4 FDD, R.2 FDD FRC (16QAM, R = 1/2): R.3 FDD FRC (64QAM, R = 3/4): R.5 FDD, R.6 FDD, R.7 FDD, R.8 FDD, R.9 FDD FRC (Single PRB): R.0 FDD, R.1 FDD FRC (two antenna ports): R.10 FDD, R.11 FDD FRC (four antenna ports): R.12 FDD, R.13 FDD, R.14 FDD FRC (FDD): R.15 FDD, R.16 FDD, R.17 FDD
RMC (UL)	Full RB (QPSK), Full RB (16QAM), Partial RB (QPSK), Partial RB (16QAM)

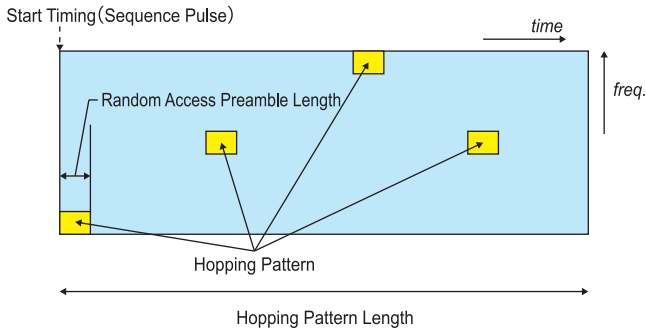

Parameters for Random Access Preamble

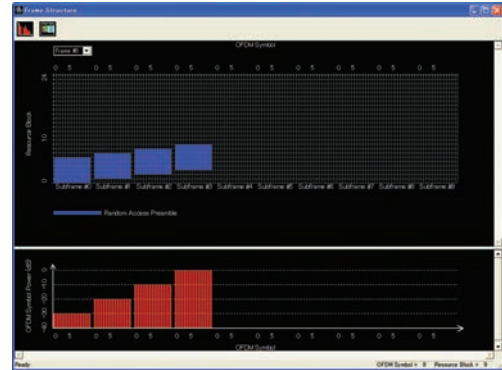

Random Access Preamble parameters setting

PRACH Configuration : 0
Data Type : Zadoff-Chu Sequence
Root Zadoff-Chu Sequence : 1
Cyclic Shift Value : 0
Hopping Pattern Length : 1
Hopping Pattern : RB#0, RB#1, RB#2, RB#3, OFF,
OFF, OFF, OFF, OFF, OFF
Power Ramping Step Size : 10.0 dB

MX370110A LTE TDD IQproducer

MX370110A-001 LTE-Advanced TDD Option



Optional

MG3710A

The MX370110A LTE TDD IQproducer is PC application software with a GUI for generating waveform patterns in compliance with the LTE TDD specifications in the 3GPP TS 36.211, TS 36.212, and TS 36.213 standards.

Generates test model waveform patterns used for LTE base station Tx tests and FRC (Fixed Reference Channel) used for Rx tests. LTE TDD IQproducer supports two setting screens: "Easy Setup Screen" and "Normal Setup Screen".

The MX370110A-001 LTE-Advanced TDD option supports simple generation of carrier aggregation signals added* by 3GPP Rel. 10. Additionally, clustered SC-FDMA signals can be generated at Uplink.

*: MBSFN reference signals, UE-specific reference signals, Positioning reference signals, CSI reference signals, Physical Multicast Channel, and Sounding Reference Signal are not supported.

Channels Generated by MX370110A LTE TDD IQproducer

- Downlink
- Cell-specific Reference Signal
 - Primary Synchronization Signal
 - Secondary Synchronization Signal
 - PBCH (Physical Broadcast Channel)
 - PCFICH (Physical Control Format Indicator Channel)
 - PDCCH (Physical Downlink Control Channel)
 - PDSCH (Physical Downlink Shared Channel)
 - PHICH (Physical Hybrid-ARQ Indicator Channel)

- Uplink
- PUCCH (Physical Uplink Control Channel)
 - PUSCH (Physical Uplink Shared Channel)
 - Demodulation Reference Signal for PUCCH/PUSCH
 - PRACH (Physical Random Access Channel)

● Easy Setup Screen

Waveform patterns can be generated easily because the main parameters are restricted to the Easy Setup screen. Use "Normal Setup function" for detailed parameter settings.

The screenshot shows the 'Easy Setup(LTE TDD)' window with the following parameters:

- System:** LTE
- Test Type:** BS Test/FRC(UL)
- Bandwidth:** 5MHz
- Cell ID:** 0
- Roll Off Length:** 0
- Ts Filter:** Ideal
- FRC(UL):** A1-1
- Uplink-downlink Configuration:** 0
- Special Subframe Configuration:** 0
- PUSCH:** Modulation: QPSK
- Start Number Of RB:** 0
- nRNTI:** 0
- hex:** (empty)
- DMRS for PUSCH:** Group Hopping: Off, Sequence Hopping: Off, Delta ss: 0, n(1)_DMRS: 0, n(2)_DMRS: 0
- Package:** LTE_TDD
- Export File Name:** TDD_FRC_A1-1_05M
- Buttons:** Calculation & Load, Calculation & Play

Surrounding windows include:

- E-UTRA Test Models:** E-TM1.1, E-TM1.2, E-TM2, E-TM3.1, E-TM3.2, E-TM3.3
- System:** LTE, LTE-Advanced
- Test Type:** 1.4MHz, 3MHz, 5MHz, 10MHz, 15MHz, 20MHz
- Bandwidth:** BS Test, E-UTRA Test Models, FRC(UL)
- Filter:** None, Ideal
- Data:** UL-SCH, Transport Block Size: 600 bit, Data Type: PN9fix
- Modulation:** QPSK, 16QAM, 64QAM

Easy Setup Screen (Example: FRC (UL))

● Normal Setup Screen

Detailed parameters are set at the Normal Setup screen to generate waveform patterns.

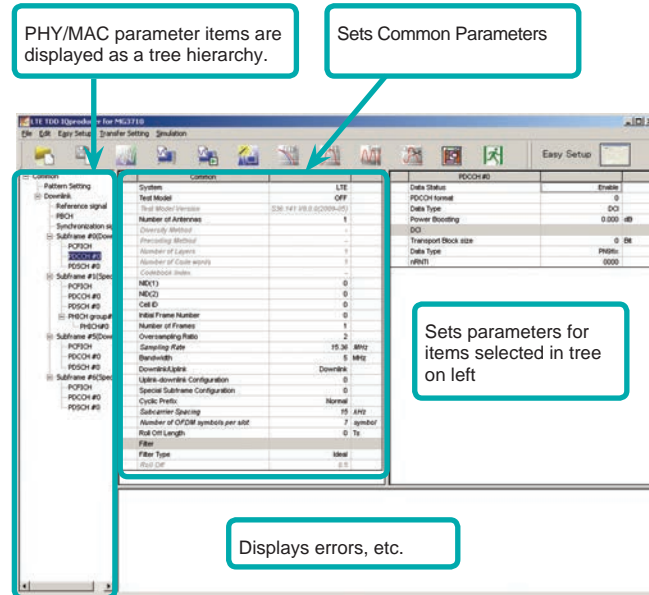

LTE TDD IQproducer Setting Screen/Normal Setup Screen

● Easy Setup Menu

3GPP-defined test conditions can be selected from the Easy Setup menu tree to set values for the Normal Setup screen parameters.

BS Test/E-UTRA Test Models

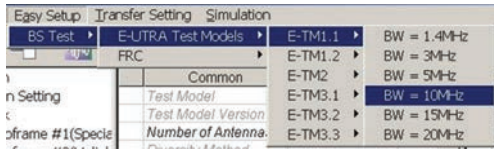

BS Test/FRC

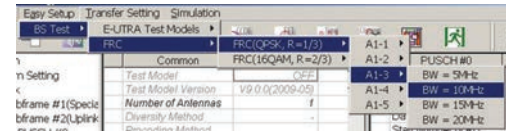

● Visual Check at Frame Structure Screen



Displays Frame Structure screen for confirming channel allocation status and power of each OFDM Symbol

The Frame Structure Screen shows the resource element allocation graphically with each channel color-coded.

Y-axis: Frequency (Resource Block units)
X-axis: Time (OFDM Symbol units)

In the Full Scale display, one frame (Subframe#0 to 9) is displayed. The zoom can be done by selecting the area with the cursor. When the Full Scale button is pushed, one frame is displayed. Moreover, when the cursor is set in each channel, and "Properties" is selected by right-clicking, information on the setting of the channel etc. is displayed.

The Power Graph shows the power relative levels of OFDM Symbols with maximum power of 0 dB.

Y-axis: OFDM Symbol Power
X-axis: Time (OFDM Symbol units)

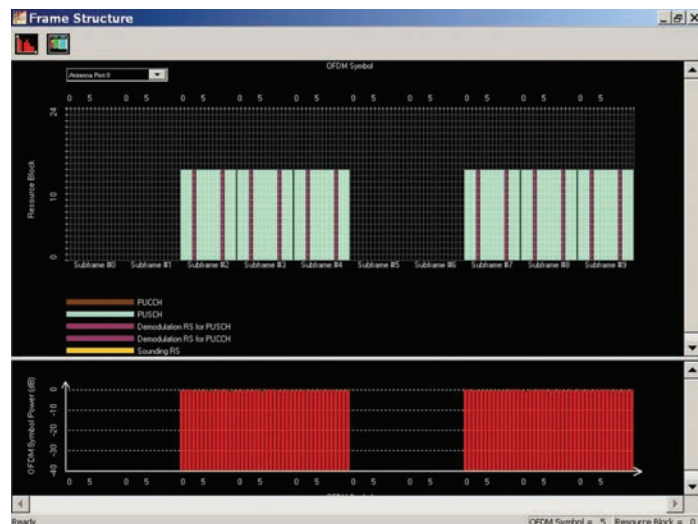

Frame Structure Screen (LTE)

MX370110A LTE TDD IQproducer MX370110A-001 LTE-Advanced TDD Option

Optional

MG3710A

MX370110A-001 LTE-Advanced TDD Option

Adding the MX370110A-001 LTE-Advanced TDD option to set LTE-Advanced system parameters supports generation of carrier aggregation signals added* by 3GPP Rel. 10. Additionally, clustered SC-FDMA signals can be generated at Uplink.

*: MBSFN reference signals, UE-specific reference signals, Positioning reference signals, CSI reference signals, Physical Multicast Channel, and Sounding Reference Signal are not supported.

LTE-Advanced Setting Parameters

Carrier Aggregation Mode

Intra-band

Component Carrier #0 to #4

Inter-band

Band #0, #1

Component Carrier #0 to #4

• Easy Setup Screen

Waveform patterns can be generated easily by setting the band matching the carrier aggregation mode and component carrier because the main parameters are restricted to the Easy Setup screen.

Use the "Normal Setup Function" for detailed parameter settings.

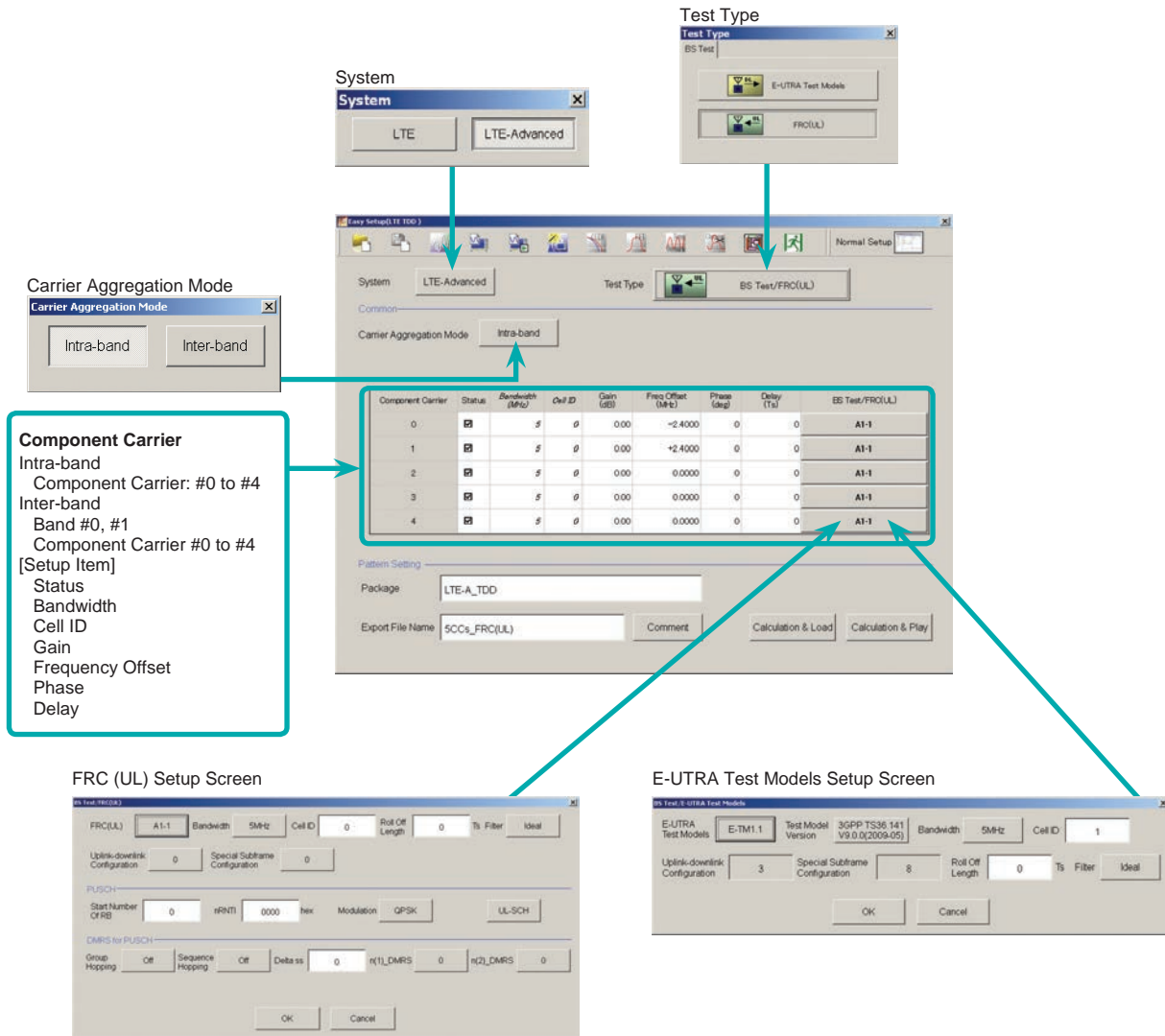

LTE-Advanced Easy Setup Screen (Example: FRC (UL) Test Type)

● Normal Setup Screen

Detailed parameters are set at the Normal Setup screen to generate waveform patterns.

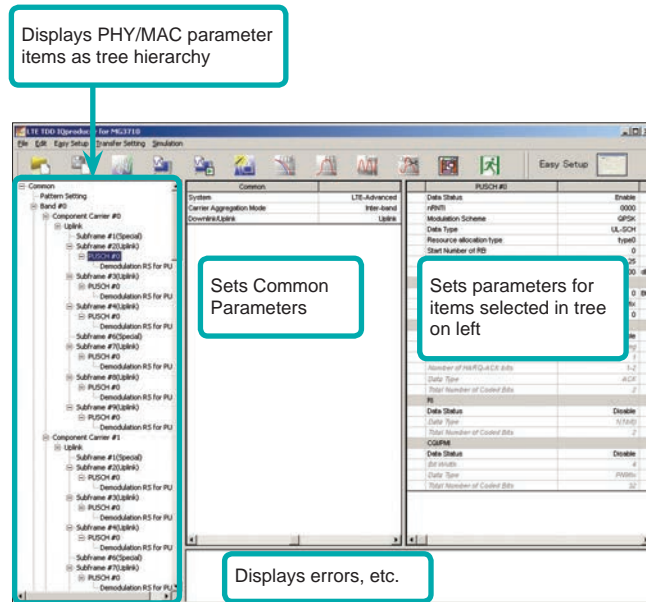

LTE-Advanced Setting Screen/Normal Setup Screen

● Easy Setup Menu

3GPP-defined test conditions can be selected from the Easy Setup menu tree to set values for the Normal Setup screen parameters.

Example: FRC Setup

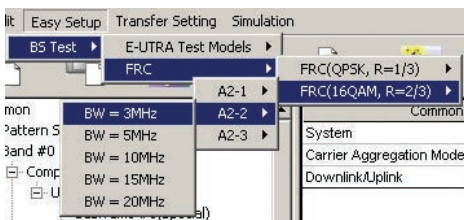

Simple operation by selecting target signals and component carriers as batch

Select Component Carrier Screen

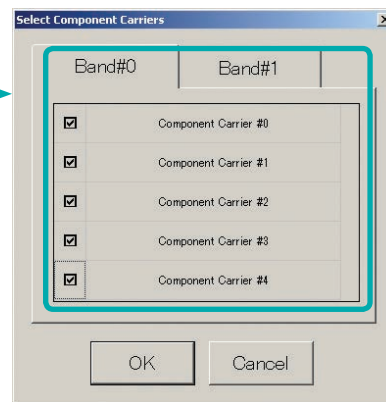

MX370110A LTE TDD IQproducer MX370110A-001 LTE-Advanced TDD Option

Optional

MG3710A

● **MG3710A Vector Signal Generator –**

One Unit Supports Carrier Aggregation Modes

The MG3710A supports an upper frequency limit of 6 GHz and an internal RF modulation bandwidth of 160 MHz*/120 MHz as well as up to two RF output connectors*2.

As a result, one unit supports LTE-Advanced carrier aggregation modes.

Calculation & Play Function*3

After waveform generation is completed, the generated pattern is loaded into memory, selected and output from the MG3710A.

When the Carrier Aggregation Mode is set to Inter-band, the Calculation & Play function can be used to load waveforms to each RF output (SG1/SG2) of the MG3710A in which two RF outputs are installed*2.

*1: Can generate and output signals for 160-MHz bandwidth max. wireless LAN (IEEE802.11ac) and for 120-MHz bandwidth.

*2: With MG3710A-062 (2.7 GHz)/064 (4 GHz)/066 (6 GHz) 2ndRF Option.

*3: This software is enabled only when used on the MG3710A.

The image shows two screenshots from the MG3710A software. The left screenshot is the 'Carrier Aggregation Mode Setup' window, where 'Inter-band' is selected. A callout box points to the 'Carrier Aggregation Mode' dropdown and lists 'Band #0' and 'Band #1'. The right screenshot is the 'SG Setting Screen' for SG1 and SG2, showing fields for 'Export File Name', 'Frequency', and 'Amplitude'. A callout box points to these fields and lists 'Frequency' and 'Amplitude'. A third callout box points to the 'Calculation & Play' button in the main interface, stating 'Simultaneously loads waveforms to two RF outputs (SG1/SG2)'.

● **Example of Vector Signal Generator Series LTE-Advanced Carrier Aggregation Function**

Carrier Aggregation Mode	Vector Signal Generator Series	Vector Signal Generator		Vector Signal Generator Option for Signal Analyzer	
		MG3710A	MG3700A	MS2690A series Opt. 020*1	MS2830A Opt. 020/021*1
Intra-band contiguous Carrier Aggregation, Intra-band non-contiguous Carrier Aggregation		✓ (1 unit)	✓ (1 unit)	✓ (1 unit)	✓ (1 unit)
Inter-band non-contiguous Carrier Aggregation		✓ (2 RF 1 unit*2, or 1 RF 2 units)	✓ (2 units)	✓ (2 units)	✓ (2 units)

*1: MX269910A LTE TDD IQproducer and MX269910A-001 LTE-Advanced TDD Option installed.

*2: MG3710A-062 (2.7 GHz)/064 (4 GHz)/066 (6 GHz) 2ndRF Option installed.

● **Example: MG3710A Supports Carrier Aggregation**

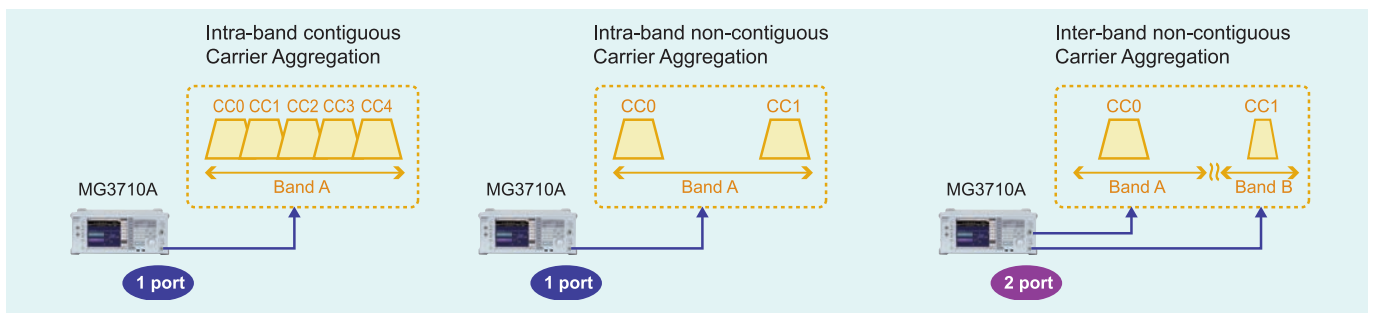

• Visual Check on Frame Structure Screen

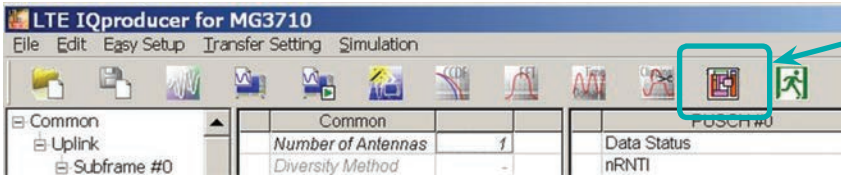

Displays Frame Structure screen for confirming channel allocation status and power of each OFDM Symbol

Power graph show/hide button

Full Scale button

Component Carrier select button

Band select button

Antenna Port select button

Display Resource Element allocation graphically with each channel color-coded.
 Y-axis: Frequency (Resource Block units)
 X-axis: Time (OFDM Symbol units)

Display power relative levels of OFDM Symbols with maximum power of 0 dB.
 Y-axis: OFDM Symbol Power
 X-axis: Time (OFDM Symbol units)

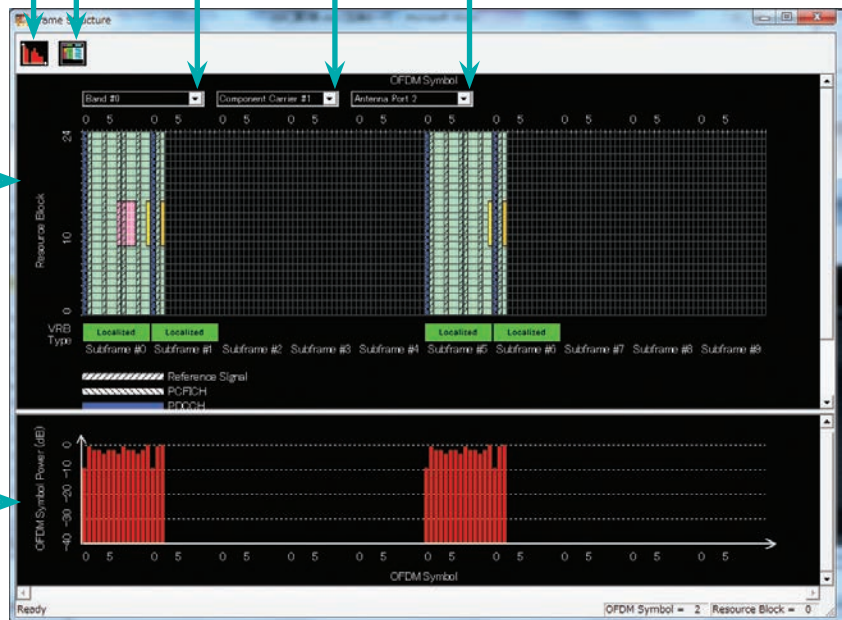

Frame Structure Screen (LTE-Advanced)

MX370110A LTE TDD IQproducer

MX370110A-001 LTE-Advanced TDD Option

Optional

MG3710A

Easy Setup Screen

● Test Type Setting Range

Display	Outline	Setting Range
Test Type	Sets the Test Type.	E-UTRA Test Models, FRC (UL)

● BS Test/E-UTRA Test Models Setting Range

Display	Outline	Setting Range
Common		
E-UTRA Test Models	Sets the E-UTRA Test Models.	E-TM1.1, E-TM1.2, E-TM2, E-TM2a, E-TM3.1, E-TM3.1a, E-TM3.2, E-TM3.3
Test Model Version	Sets the Test Model version of referred specifications.	3GPP TS 36.141 V8.2.0 (2009-03) 3GPP TS 36.141 V9.0.0 (2009-05)
Bandwidth	Sets the system bandwidth.	1.4, 3, 5, 10, 15, 20 MHz
Cell ID	Sets the Cell ID.	0 to 153
Uplink-downlink Configuration	Sets the Uplink-downlink Configuration.	3 fixed
Special Subframe Configuration	Sets the Special Subframe Configuration.	8 fixed
Roll Off Length	Sets the length of the ramp time applied to the OFDM symbol.	0 to 144
Filter	Sets filter.	Ideal, None

● BS Test/FRC (UL) Setting Range

Display	Outline	Setting Range
Common		
FRC (UL)	Selects the setting items described in 3GPP TS 36.141 Annex A and automatically sets the parameters.	A1-1, A1-2, A1-3, A1-4, A1-5, A2-1, A2-2, A2-3
Bandwidth	Sets the system bandwidth.	The settable bandwidth changes according to the selected FRC (UL).
Cell ID	Sets the Cell ID.	0 to 503
Roll Off Length	Sets the length of the ramp time applied to the OFDM symbol.	0 to 144
Filter	Sets the filter type.	Ideal, None
Uplink-downlink configuration	Sets the Uplink-downlink Configuration.	0, 1, 2, 3, 4, 5, 6
Special Subframe Configuration	Sets the Special Subframe Configuration.	0 to 8
PUSCH		
Start Number of RB	Sets the start position of the RB to which the PUSCH is assigned.	Bandwidth = 1.4 MHz: 0 to (6-allocated resource block) Bandwidth = 3 MHz: 0 to (15-allocated resource block) Bandwidth = 5 MHz: 0 to (25-allocated resource block) Bandwidth = 10 MHz: 0 to (50-allocated resource block) Bandwidth = 15 MHz: 0 to (75-allocated resource block) Bandwidth = 20 MHz: 0 to (100-allocated resource block)
nRNTI	Sets the radio network temporary identifier.	0 to FFFF
Modulation	Sets the modulation mode.	QPSK, 16QAM, 64QAM
UL-SCH		
Transport Block Size	Sets the transport block size for UL-SCH.	0 to 86400
Data Type	Sets the Data type.	PN9fix, PN15fix, All0, All1
DMRS for PUSCH		
Group Hopping	Enables or disables group hopping.	Off, On
Sequence Hopping	Enables or disables Sequence Hopping.	Off, On
Delta ss	Sets Delta ss.	0 to 29
n(1)_DMRS	Sets the value used for automatic n_cs calculation.	0, 2, 3, 4, 6, 8, 9, 10
n(2)_DMRS	Sets the value used for automatic n_cs calculation.	0, 2, 3, 4, 6, 8, 9, 10

Easy Setup Screen (System = LTE-Advanced)

● Test Type Setting Range

Display	Outline	Setting Range
Test Type	Sets the Test Type	E-UTRA Test Models, FRC (UL)

● BS Test/E-UTRA Test Models Setting Range

Display	Outline	Setting Range
E-UTRA Test Models	Sets the E-UTRA Test Models	E-TM1.1, E-TM1.2, E-TM2, E-TM2a, E-TM3.1, E-TM3.1a, E-TM3.2, E-TM3.3
Test Model Version	Sets the Test Model version of referred specifications.	3GPP TS 36.141 V8.2.0 (2009-03), 3GPP TS 36.141 V9.0.0 (2009-05)
Bandwidth	Sets the system bandwidth	1.4, 3, 5, 10, 15, 20 MHz
Cell ID	Sets the Cell ID	0 to 503
Uplink-downlink Configuration	Sets the Uplink-downlink configuration	When the Test Type is BS Test/E-UTRA Test Models, the setting is fixed to 3.
Special Subframe Configuration	Sets the Special Subframe configuration	When the Test Type is BS Test/E-UTRA Test Models, the setting is fixed to 8.
Roll Off Length	Sets the length of the ramp time applied to the OFDM symbol	0 to 144
Filter	Sets filter	Ideal, None

MX370110A LTE TDD IQproducer MX370110A-001 LTE-Advanced TDD Option

Optional

MG3710A

● BS Test/FRC (UL) Setting Range

Display	Outline	Setting Range
Common		
FRC (UL)	Selects the setting items described in 3GPP TS 36.141 Annex A and automatically sets the parameters	A1-1, A1-2, A1-3, A1-4, A1-5, A2-1, A2-2, A2-3
Bandwidth	Sets the system bandwidth	The settable bandwidth changes according to the selected FRC (UL)
Cell ID	Sets the Cell ID	0 to 503
Roll Off Length	Sets the length of the ramp time applied to the OFDM symbol	0 to 144
Filter	Sets the filter type	Ideal, None
Uplink-downlink Configuration	Sets the Uplink-downlink configuration	0, 1, 2, 3, 4, 5, 6
Special Subframe Configuration	Sets the Special Subframe configuration	0 to 8
PUSCH		
Start Number of RB	Sets the start position of the RB to which the PUSCH is assigned	Bandwidth = 1.4 MHz: 0 to (6-allocated resource block) Bandwidth = 3 MHz: 0 to (15-allocated resource block) Bandwidth = 5 MHz: 0 to (25-allocated resource block) Bandwidth = 10 MHz: 0 to (50-allocated resource block) Bandwidth = 15 MHz: 0 to (75-allocated resource block) Bandwidth = 20 MHz: 0 to (100-allocated resource block)
nRNTI	Sets the radio network temporary identifier	0 to FFFF
Modulation	Sets the modulation mode	QPSK, 16QAM, 64QAM
UL-SCH		
Transport Block Size	Sets the transport block size for UL-SCH	0 to 86400
Data Type	Sets the Data type	PN9fix, PN15fix, All0, All1
DMRS for PUSCH		
Group Hopping	Enables or disables group hopping	Off, On
Sequence Hopping	Enables or disables Sequence Hopping	Off, On
Delta ss	Sets Delta ss	0 to 29
n (1)_DMRS	Sets the value used for automatic n_cs calculation	0, 2, 3, 4, 6, 8, 9, 10
n (2)_DMRS	Sets the value used for automatic n_cs calculation	0, 2, 3, 4, 6, 8, 9, 10

● Carrier Aggregation Mode Setting Range

Display	Outline	Setting Range														
Carrier Aggregation Mode	Sets the Carrier Aggregation Mode	Intra-band, Inter-band														
Parameter																
Component Carrier	Displays the Component Carrier number	Display only														
Status	Enables or disables the Component Carrier parameter	Check box selected, or cleared														
Bandwidth	Displays the system bandwidth for the Component Carrier	Display only														
Cell ID	Displays the cell ID for the Component Carrier	Display only														
Gain	Sets the level ratio of Component Carrier	-80.00 to 0.00 [dB]														
Freq. Offset	Sets the frequency offset	0 to $\pm (0.4 \times Fs - 0.5 \times \text{Band})$ [MHz] Band: Changed depending on the Component Carrier# transmission system bandwidth (Bandwidth) <table border="1" style="margin-left: auto; margin-right: auto;"> <thead> <tr> <th>Bandwidth [MHz]</th> <th>Band [MHz]</th> </tr> </thead> <tbody> <tr> <td>1.4</td> <td>1.095</td> </tr> <tr> <td>3.0</td> <td>2.715</td> </tr> <tr> <td>5.0</td> <td>4.515</td> </tr> <tr> <td>10.0</td> <td>9.015</td> </tr> <tr> <td>15.0</td> <td>13.515</td> </tr> <tr> <td>20.0</td> <td>18.015</td> </tr> </tbody> </table> Fs: 153.6 MHz (sampling rate)	Bandwidth [MHz]	Band [MHz]	1.4	1.095	3.0	2.715	5.0	4.515	10.0	9.015	15.0	13.515	20.0	18.015
Bandwidth [MHz]	Band [MHz]															
1.4	1.095															
3.0	2.715															
5.0	4.515															
10.0	9.015															
15.0	13.515															
20.0	18.015															
Phase	Sets the initial phase of the Component Carrier	0 to 359 [deg.]														
Delay	Sets delay of the Component Carrier	0 to 307200 [Ts]														
BS Test Type	Sets the details of BS Test Type of Component Carriers	BS Test/E-UTRA Test Models, BS Test/FRC(UL)														

● Pattern Setting Setting Range

Display	Outline	Setting Range
Package	Enters waveform pattern package name	Up to 31 single-byte English alphanumeric characters
Export File Name	Enters waveform pattern file name	Carrier Aggregation Mode = Intra-band : Up to 18 single-byte English alphanumeric characters Carrier Aggregation Mode = Inter-band : Up to 15 single-byte English alphanumeric characters
Comment	Inputs comments to the waveform pattern	Up to 38 single-byte English alphanumeric characters x 3 lines

MX370110A LTE TDD IQproducer

MX370110A-001 LTE-Advanced TDD Option

Optional

MG3710A

Normal Setup Screen

Display	Outline	Setting Range
System	Switches 3GPP Systems	LTE, LTE-Advanced

● Common Parameter Setting Range (System = LTE)

Display	Outline	Setting Range
Common		
Test Model	Sets test model	OFF, E-TM1.1, E-TM1.2, E-TM2, E-TM3.1, E-TM3.2, E-TM3.3
Test Model Version	Sets the Test Model version of referred specifications	3GPP TS 36.141 V8.2.0 (2009-03) 3GPP TS 36.141 V9.0.0 (2009-05)
Number of Antennas	Sets number of antennas	1, 2, 4 (2 and 4 only at Downlink)
Diversity Method	Sets diversity method	Spatial Multiplexing, Tx Diversity
Precoding Method	Sets precoding method	Without CDD, Large-delay CDD
Number of Layers	Sets number of layers	1, 2, 3, 4
Number of Code words	Sets number of code words	1, 2
Codebook Index	Sets codebook index	0 to 3 (When Number of Layers = 1) 0 to 2 (When Number of Layers = 2) 0 to 15 (When Number of Antennas = 4)
NID (1)	Sets physical-layer cell-identity group NID (1)	0 to 167
NID (2)	Sets physical-layer cell-identity group NID (2)	0, 1, 2
Cell ID	Sets cell ID	0 to 503
Number of Frames	Sets number of frames	1 to max. number of frames in memory
Oversampling Ratio	Sets over sampling ratio	2, 4
Sampling Rate	Displays sampling rate	1.92 × Over Sampling Ratio [MHz] (When Bandwidth = 1.4 MHz) 3.84 × Over Sampling Ratio [MHz] (When Bandwidth = 3 MHz) 7.68 × Over Sampling Ratio [MHz] (When Bandwidth = 5 MHz) 15.36 × Over Sampling Ratio [MHz] (When Bandwidth = 10 MHz) 15.36 × Over Sampling Ratio [MHz] (When Bandwidth = 15 MHz) 30.72 × Over Sampling Ratio [MHz] (When Bandwidth = 20 MHz)
Bandwidth	Sets system bandwidth	1.4, 3, 5, 10, 15, 20 MHz
Downlink/Uplink	Sets downlink/uplink settings	Downlink, Uplink
Uplink-downlink Configuration	Sets uplink-downlink Configuration	0, 1, 2, 3, 4, 5, 6
Special Subframe Configuration	Sets special subframe Configuration	0 to 8
Cyclic Prefix	Sets cyclic prefix	Normal, Extended
Subcarrier Spacing	Displays subcarrier spacing	15 kHz
Number of OFDM symbols per slot	Displays number of OFDM symbols per slot	7 Symbols (When Cyclic Prefix = Normal) 6 Symbols (When Cyclic Prefix = Extended)
Roll Off Length	Sets roll-off length for OFDM symbol	0 to 144 Ts (When Cyclic Prefix = Normal) 0 to 512 Ts (When Cyclic Prefix = Extended)
Filter		
Filter Type	Sets filter type	Nyquist, Root Nyquist, Ideal, None
Roll Off	Sets roll-off rate	0.1 to 1.0 (only enabled for Nyquist, Root Nyquist)

● Common Parameter Setting Range (System = LTE-Advanced)

Display	Outline	Setting Range
Carrier Aggregation Mode	Sets the Carrier Aggregation Mode	Intra-band, Inter-band
Downlink/Uplink	Sets downlink or uplink	Downlink, Uplink

● PHY/MAC Parameter Setting Range (LTE-Advanced)

Display	Outline	Setting Range														
Carrier Aggregation																
Component Carrier	Displays the Component Carrier number	0 to 4														
Status	Enables or disables the Component Carrier parameter	Check box selected, or cleared														
Bandwidth	Displays the system bandwidth for the Component Carrier	Display only														
Cell ID	Displays the Cell ID for the Component Carrier	Display only														
Gain	Sets the level ratio of Component Carrier	-80.00 to 0.00 [dB]														
Freq. Offset	Sets the frequency offset	0 to ± (0.4 × Fs - 0.5 × Band) [MHz] Band: Changed depending on the Component Carrier transmission system bandwidth (Bandwidth) <table border="1" style="margin-left: 20px;"> <thead> <tr> <th>Bandwidth [MHz]</th> <th>Band [MHz]</th> </tr> </thead> <tbody> <tr> <td>1.4</td> <td>1.095</td> </tr> <tr> <td>3.0</td> <td>2.715</td> </tr> <tr> <td>5.0</td> <td>4.515</td> </tr> <tr> <td>10.0</td> <td>9.015</td> </tr> <tr> <td>15.0</td> <td>13.515</td> </tr> <tr> <td>20.0</td> <td>18.015</td> </tr> </tbody> </table>	Bandwidth [MHz]	Band [MHz]	1.4	1.095	3.0	2.715	5.0	4.515	10.0	9.015	15.0	13.515	20.0	18.015
Bandwidth [MHz]	Band [MHz]															
1.4	1.095															
3.0	2.715															
5.0	4.515															
10.0	9.015															
15.0	13.515															
20.0	18.015															
Phase	Sets the initial phase of the Component Carrier	0 to 359 [deg.]														
Delay	Sets delay of the Component Carrier	0 to 307200 [Ts]														

MX370110A LTE TDD IQproducer MX370110A-001 LTE-Advanced TDD Option

Optional

MG3710A

Display	Outline	Setting Range
Component Carrier		
Test Model	Sets the Test Model	OFF, E-TM1.1, E-TM1.2, E-TM2, E-TM3.1, E-TM3.2, E-TM3.3
Test Model Version	sets the Test Model version of referred specifications	3GPP TS 36.141 V8.2.0 (2009-03), 3GPP TS 36.141 V9.0.0 (2009-05)
Number of Antennas	Sets the number of antennas	1, 2, 4
Diversity Method	Sets the diversity method	Spatial Multiplexing, Tx Diversity
Precoding Method	Sets the precoding method	Without CDD, Large-delay CDD, Large-delay CDD (Cyclic Precoder Index)
Number of Layers	Sets the number of layers	1, 2, 3, 4
Number of Code words	Sets the number of code words	1, 2
Codebook index	Sets the codebook index	When Number of Antennas is 2, the setting range varies according to Number of Layers as follows Number of Layers is 1: 0 to 3 Number of Layers is 2: 0 to 2 When Number of Antennas is 4: 0 to 15
NID (1)	Sets the NID (1)	0 to 167
NID (2)	Sets the NID (2)	0, 1, 2
Cell ID	Sets the Cell ID	0 to 503
Number of Frames	Sets the number of frames to be generated	1 to the maximum number of frames that can be stored in the equipment's waveform memory
Over Sampling Ratio	Sets the oversampling ratio	1, 2, 4
Sampling Rate	Displays the sampling rate	Display only : It is automatically set according to the Oversampling Ratio and Bandwidth values
Bandwidth	Sets the system bandwidth	1.4, 3, 5, 10, 15, 20 MHz
Downlink/Uplink	Sets downlink or uplink	Downlink, Uplink
Uplink-downlink Configuration	Sets the Uplink-downlink Configuration	0, 1, 2, 3, 4, 5, 6
Special Subframe Configuration	Sets the Special Subframe Configuration	0 to 8
Cyclic Prefix	Sets the cyclic prefix	Normal, Extended
Subcarrier Spacing	Displays the subcarrier spacing (interval)	Display only
Number of OFDM symbols per slot	Sets the number of OFDM symbols per slot	Display only
Roll Off Length	Sets the length of the ramp time applied to the OFDM symbol	0 to 3152 Ts (in the case of Random Access Preamble) 0 to 144 Ts (when Cyclic prefix=Normal) 0 to 512 Ts (when Cyclic prefix=Extende) 432 Ts (in the case of PRACH)
Filter		
Filter Type	Sets the filter type	Nyquist, Root Nyquist, Ideal, None
Roll Off	Sets the roll-off factor	0.1 to 1.0

● **Pattern Setting Parameter Setting Range**

Display	Outline	Setting Range
Reference signal		
Package	Set package name of waveform pattern	31 characters or less
Export File Name	Set pattern name of waveform pattern	18 characters or less
Line1	Set comment of waveform pattern	38 characters or less
Line2	Set comment of waveform pattern	38 characters or less
Line3	Set comment of waveform pattern	38 characters or less

Table 1

Subframe	UL/DL Configuration						
	0	1	2	3	4	5	6
0	D	D	D	D	D	D	D
1	S	S	S	S	S	S	S
2	U	U	U	U	U	U	U
3	U	U	D	U	U	D	U
4	U	D	D	U	D	D	U
5	D	D	D	D	D	D	D
6	S	S	S	D	D	D	S
7	U	U	U	D	D	D	U
8	U	U	D	D	D	D	U
9	U	D	D	D	D	D	D

Table 2

UL/DL Configuration	Subframe turned "off"
0	–
1	0, 5
2	0, 1, 4, 5, 6, 9
3	1, 5, 6, 7
4	0, 1, 4, 5, 6, 7
5	0, 1, 3, 4, 5, 6, 7, 9
6	–

MX370110A LTE TDD IQproducer

MX370110A-001 LTE-Advanced TDD Option

Optional

MG3710A

PHY/MAC Parameter (Downlink) Setting Range

Display	Outline	Setting Range
Downlink		
PHICH duration	Sets the PHICH area.	Normal, Extended
Ng	Sets the parameter (Ng) for determining the PHICH arrangement.	1/6, 1/2
Reference Signal		
Frequency Shift Value	Displays frequency shift	0, 1, 2, 3, 4, 5
Power Boosting	Sets power boosting	-20.000 to +20.000 dB
PBCH		
Data Status	Enable/disables PBCH parameter	Disable, Enable
Data Type	Sets data type	PN9fix, PN15fix, 16bit repeat, User File, BCH
Data Type Repeat Data	Sets 16bit repeat data	0000 to FFFF (only when Data Type = 16bit repeat)
Data Type User File	Sets user file	Select any file (only when Data Type = User File)
Power Boosting	Sets power boosting	-20.000 to +20.000 dB
BCH		
Data Type	Sets data type	PN9fix, PN15fix, 16bit repeat, User File, BCCH
Data Type Repeat Data	Sets 16bit repeat data	0000 to FFFF (only when Data Type = 16bit repeat)
Data Type User File	Sets user file	Select any file (only when Data Type = User File)
Transport Block Size	Sets number of bits required for BCH	0 to 1920 bits (When Cyclic Prefix = Normal) 0 to 1728 bits (When Cyclic Prefix = Extended) When BCCH is selected for BCH Data Type, the setting is fixed to 24 bits.
DL Bandwidth	Displays data mapped to BCCH	n6 (When Bandwidth = 1.4 MHz) n15 (When Bandwidth = 3 MHz) n25 (When Bandwidth = 5 MHz) n50 (When Bandwidth = 10 MHz) n75 (When Bandwidth = 15 MHz) n100 (When Bandwidth = 20 MHz) This is only displayed when BCCH is selected for Data Type of BCH.
PHICH duration	Displays the PHICH duration mapped to BCCH	Normal, Extended This is only displayed when BCCH is selected for Data Type of BCH.
Ng	Displays the Ng value mapped to BCCH	1/6, 1/2, 1, 2 This is only displayed when BCCH is selected for Data Type of BCH.
Synchronization Signals		
Primary Synchronization Signal		
Data Status	Enable/disables primary synchronization signal parameter	Disable, Enable
Power Boosting	Sets power boosting	-20.000 to +20.000 dB
Secondary Synchronization Signal		
Data Status	Enable/disables secondary synchronization signal parameter	Disable, Enable
Power Boosting	Sets power boosting	-20.000 to +20.000 dB
Subframe #0 to #9		
Subframe Type	Display subframe type	<Table1> (Downlink, Uplink, Special)
Virtual Resource Block Type	Display virtual resource block type	Localized, Distributed
Gap	Sets Gap	1st Gap, 2nd Gap If Bandwidth is 1.4 MHz, 3 MHz, or 5 MHz, 1st Gap is displayed and Gap cannot be set. If Bandwidth is 10 MHz, 15 MHz, or 20 MHz, 1st Gap or 2nd Gap can be set.
Gap value	Displays Gap value	
Number of VRBs	Displays the number of VRB	
PHICH	Sets ON/OFF of PHICH	ON, OFF (Subframe in Table 2 is turned off by setting UL/DL Configuration)
Number of PHICH Groups	Displays number of PHICH groups in one subframe	
Number of OFDM symbols for PDCCH	Sets number of OFDM symbols for PDCCH	1 to 4 Symbol
Total Number of CCEs	Display total number of CCEs of control area in subframe	
Number of PDCCHs	Sets number of PDCCHs	1 to 64
CCE Arrangement	Sets CCE arrangement	PDCCH#0 to (Number of PDCCHs-1), dummy
Number of PDSCHs	Sets number of PDSCHs	1 to 64
RB Arrangement	Sets RB arrangement of PDSCH	PDSCH#0 to (Number of PDSCHs-1)
PCFICH		
Data Status	Enable/disables PCFICH parameter	Disable, Enable
Data Type	Sets data type	CFI codeword, PN9fix, PN15fix, 16bit repeat, User File
CFI	Sets CFI codeword type	1, 2, 3
Data Type Repeat Data	Sets 16bit repeat data	0000 to FFFF (only when Data Type = 16bit repeat)
Data Type User File	Sets user file	Select any file (only when Data Type = User File)
Power Boosting	Sets power boosting	-20.000 to +20.000 dB
PDCCH		
Data Status	Enable/disables PDCCH parameter	Disable, Enable
PDCCH format	Sets PDCCH format	0, 1, 2, 3
Data Type	Sets data type	PN9fix, PN15fix, 16bit repeat, User File, DCI
Data Type Repeat Data	Sets 16bit repeat data	0000 to FFFF (only when Data Type = 16bit repeat)
Data Type User File	Sets user file	Select any file (only when Data Type = User File)
Power Boosting	Set power boosting	-20.000 to +20.000 dB

MX370110A LTE TDD IQproducer MX370110A-001 LTE-Advanced TDD Option

Optional

MG3710A

Display	Outline	Setting Range
DCI		
Data Type	Sets data type	PN9fix, PN15fix, 16bit repeat, User File
Data Type Repeat Data	Sets 16bit repeat data	0000 to FFFF (only when Data Type = 16bit repeat)
Data Type User File	Sets user file	Select any file (only when Data Type = User File)
Transport Block Size	Sets number of bits required for DCI	0 to 576
nRNTI	Sets radio network temporary identifier	0000 to FFFF
PDSCH		
Data Status	Enable/disables PDSCH parameter	Disable, Enable
nRNTI	Sets radio network temporary identifier	0000 to FFFF
Modulation Scheme	Sets modulation scheme	QPSK, 16QAM, 64QAM, 256QAM
Data Type	Sets data type	PN9fix, PN15fix, 16bit repeat, User File, DL-SCH
Data Type Repeat Data	Sets 16bit repeat data	0000 to FFFF (only when Data Type = 16bit repeat)
Data Type User File	Sets user file	Select any file (only when Data Type = User File)
Power Boosting	Sets power boosting	-20.000 to +20.000 dB
DL-SCH		
Data Type	Sets data type	PN9fix, PN15fix, 16bit repeat, User File
Data Type Repeat Data	Sets 16bit repeat data	0000 to FFFF (only when Data Type = 16bit repeat)
Data Type User File	Sets user file	Select any file (only when Data Type = User File)
Transport Block Size	Sets number of bits required for DL-SCH	0 to 1500000 bit
UE Category	Sets UE category	1, 2, 3, 4, 5
RV Index	Sets redundancy version index	0, 1, 2, 3
PHICH Group		
Data Status	Enable/disables PHICH parameter	Disable, Enable
Number of PHICHs	Sets number of PHICH	1 to 8 (Cyclic Prefix = Normal), 1 to 4 (Cyclic Prefix = Extended)
Power Boosting	Display power boosting of PHICH group	
PHICH #0 to # (Number of PHICHs-1)		
Data Status	Enable/disables PHICH parameter	Disable, Enable
Orthogonal Sequence Index	Sets orthogonal sequence index	0 to 7 (When Cyclic Prefix = Normal), 0 to 3 (When Cyclic Prefix = Extended)
Data Type	Display data type	HI
HI	Sets code word of HI (HARQ indicator)	000, 111
Power Boosting	Set power boosting	-20.000 to +20.000 dB

● PHY/MAC Parameter (Uplink) Setting Range

Display	Outline	Setting Range
Uplink		
Data Transmission/PRACH	Selects Data Transmission or PRACH	Data Transmission, PRACH
DMRS Parameters	Sets the calculation method of Demodulation RS parameter.	Auto, Manual
PUCCH Parameters		
Delta PUCCH shift	Sets delta PUCCH shift	1, 2, 3
N_CS(1)	Sets number of cyclic shift for PUCCH format 1/1a/1b	0 to 7
N_RB(2)	Sets number of resource block for PUCCH format 2/2a/2b	0 to 63
Subframe #0 to #9		
Subframe Type	Display subframe type	<Table 1> (Downlink, Uplink, Special)
Number of PUCCHs	Sets number of PUCCHs	0 to 8
Number of PUSCHs	Sets number of PUSCHs	0 to 8
PUCCH #0 to #7		
Data Status	Enables/disables PUCCH parameter	Disable, Enable
n(1)_PUCCH	Sets resource number of PUCCH 1/1a/1b	0 to 764
n(2)_PUCCH	Sets resource number of PUCCH 2/2a/2b	0 to 764
nRNTI	Sets radio network temporary identifier	0000 to FFFF
PUCCH format	Sets PUCCH format	1, 1a, 1b, 2, 2a, 2b
Data Type	Sets data type	PN9fix, PN15fix, 16bit repeat, User File, UCI
Data Type Repeat Data	Sets 16bit repeat data	0000 to FFFF (only when Data Type = 16bit repeat)
Data Type User File	Sets user file	Select any file (only when Data Type = User File)
Group Hopping	Sets enable/disables	Disable, Enable
Base Sequence Group Number u	Sets base sequence group number	0 to 29 When Group Hopping is enabled this parameter becomes invalid and cannot be set. When DMRS Parameters is Auto, only calculated value displays and nothing can be set.
Base Sequence Number v	Displays base sequence number	0 fixed
Power Boosting	Sets power boosting	-20.000 to +20.000 dB

MX370110A LTE TDD IQproducer

MX370110A-001 LTE-Advanced TDD Option

Optional

MG3710A

Display	Outline	Setting Range																					
UCI																							
Transport Block Size	Sets transport block size of UCI	1 (When PUCCH format = 1a) 2 (When PUCCH format = 1b) 1 to 13 (When PUCCH format = 2) 2 to 14 (When PUCCH format = 2a) 3 to 15 (When PUCCH format = 2b)																					
Data Type	Sets data type	PN9fix, PN15fix, 16bit repeat, User File																					
Data Type Repeat Data	Sets 16bit repeat data	0000 to FFFF (only when Data Type = 16bit repeat)																					
Data Type User File	Sets user file	Select any file (only when Data Type = User File)																					
Demodulation RS for PUCCH																							
Group Hopping	Sets enable/disables	Disable, Enable																					
Base Sequence Group Number u	Sets base sequence group number	0 to 29																					
Base Sequence Number v	Displays base sequence number	0 fixed																					
PUSCH #0 to #7																							
Data Status	Enables/disables PUSCH parameter	Disable, Enable																					
nRNTI	Sets radio network temporary identifier	0000 to FFFF																					
Modulation Scheme	Sets the modulation scheme	QPSK, 16QAM, 64QAM																					
Data Type	Sets data type	PN9fix, PN15fix, 16bit repeat, User File, UL-SCH																					
Data Type Repeat Data	Sets 16bit repeat data	0000 to FFFF (only when Data Type = 16bit repeat)																					
Data Type User File	Sets user file	Select any file (only when Data Type = User File)																					
Resource allocation type	Sets the Resource allocation type	type0, type1																					
Start Number of RB	Start position of RB	0 to 5 (When Bandwidth = 1.4 MHz) 0 to 14 (When Bandwidth = 3 MHz) 0 to 24 (When Bandwidth = 5 MHz) 0 to 49 (When Bandwidth = 10 MHz) 0 to 74 (When Bandwidth = 15 MHz) 0 to 99 (When Bandwidth = 20 MHz)																					
Number of RBs	Total number of RB	1 to 6 (When Bandwidth = 1.4 MHz) 1 to 15 (When Bandwidth = 3 MHz) 1 to 25 (When Bandwidth = 5 MHz) 1 to 50 (When Bandwidth = 10 MHz) 1 to 75 (When Bandwidth = 15 MHz) 1 to 100 (When Bandwidth = 20 MHz)																					
Start Number of RBG for 1st	Sets the start position of the RBG for 1st	The setting range varies depending on the Bandwidth setting as follows <table border="1"> <thead> <tr> <th>Bandwidth (Number of RBs)</th> <th>Setting range*</th> </tr> </thead> <tbody> <tr> <td>1.4 MHz (6)</td> <td>1 to 4</td> </tr> <tr> <td>3 MHz (15)</td> <td>1 to 6</td> </tr> <tr> <td>5 MHz (25)</td> <td>1 to 11</td> </tr> <tr> <td>10 MHz (50)</td> <td>1 to 15</td> </tr> <tr> <td>15 MHz (75)</td> <td>1 to 17</td> </tr> <tr> <td>20 MHz (100)</td> <td>1 to 23</td> </tr> </tbody> </table> <p>*: The maximum value of the setting range is smaller than End Number of RBG for 1st + 1</p>	Bandwidth (Number of RBs)	Setting range*	1.4 MHz (6)	1 to 4	3 MHz (15)	1 to 6	5 MHz (25)	1 to 11	10 MHz (50)	1 to 15	15 MHz (75)	1 to 17	20 MHz (100)	1 to 23							
Bandwidth (Number of RBs)	Setting range*																						
1.4 MHz (6)	1 to 4																						
3 MHz (15)	1 to 6																						
5 MHz (25)	1 to 11																						
10 MHz (50)	1 to 15																						
15 MHz (75)	1 to 17																						
20 MHz (100)	1 to 23																						
End Number of RBG for 1st	Sets the end position of the RBG for 1st	The setting range varies depending on the Bandwidth setting as follows <table border="1"> <thead> <tr> <th>Bandwidth (Number of RBs)</th> <th>Setting range*</th> <th>Default</th> </tr> </thead> <tbody> <tr> <td>1.4 MHz (6)</td> <td>1 to 4</td> <td>3</td> </tr> <tr> <td>3 MHz (15)</td> <td>1 to 6</td> <td>3</td> </tr> <tr> <td>5 MHz (25)</td> <td>1 to 11</td> <td>6</td> </tr> <tr> <td>10 MHz (50)</td> <td>1 to 15</td> <td>8</td> </tr> <tr> <td>15 MHz (75)</td> <td>1 to 17</td> <td>8</td> </tr> <tr> <td>20 MHz (100)</td> <td>1 to 23</td> <td>12</td> </tr> </tbody> </table> <p>*: The maximum value of the setting range is smaller than End Number of RBG for 1st + 1</p>	Bandwidth (Number of RBs)	Setting range*	Default	1.4 MHz (6)	1 to 4	3	3 MHz (15)	1 to 6	3	5 MHz (25)	1 to 11	6	10 MHz (50)	1 to 15	8	15 MHz (75)	1 to 17	8	20 MHz (100)	1 to 23	12
Bandwidth (Number of RBs)	Setting range*	Default																					
1.4 MHz (6)	1 to 4	3																					
3 MHz (15)	1 to 6	3																					
5 MHz (25)	1 to 11	6																					
10 MHz (50)	1 to 15	8																					
15 MHz (75)	1 to 17	8																					
20 MHz (100)	1 to 23	12																					
Start Number of RBG for 2nd	Sets the start position of the RBG for 2nd	The setting range varies depending on the Bandwidth setting as follows <table border="1"> <thead> <tr> <th>Bandwidth (Number of RBs)</th> <th>Setting range*</th> <th>Default</th> </tr> </thead> <tbody> <tr> <td>1.4 MHz (6)</td> <td>3 to 6</td> <td>5</td> </tr> <tr> <td>3 MHz (15)</td> <td>3 to 8</td> <td>5</td> </tr> <tr> <td>5 MHz (25)</td> <td>3 to 13</td> <td>8</td> </tr> <tr> <td>10 MHz (50)</td> <td>3 to 17</td> <td>10</td> </tr> <tr> <td>15 MHz (75)</td> <td>3 to 19</td> <td>10</td> </tr> <tr> <td>20 MHz (100)</td> <td>3 to 25</td> <td>14</td> </tr> </tbody> </table> <p>*: The maximum value of the setting range is smaller than End Number of RBG for 1st + 1</p>	Bandwidth (Number of RBs)	Setting range*	Default	1.4 MHz (6)	3 to 6	5	3 MHz (15)	3 to 8	5	5 MHz (25)	3 to 13	8	10 MHz (50)	3 to 17	10	15 MHz (75)	3 to 19	10	20 MHz (100)	3 to 25	14
Bandwidth (Number of RBs)	Setting range*	Default																					
1.4 MHz (6)	3 to 6	5																					
3 MHz (15)	3 to 8	5																					
5 MHz (25)	3 to 13	8																					
10 MHz (50)	3 to 17	10																					
15 MHz (75)	3 to 19	10																					
20 MHz (100)	3 to 25	14																					
End Number of RBG for 2nd	Sets the end position of the RBG for 2nd	The setting range varies depending on the Bandwidth setting as follows <table border="1"> <thead> <tr> <th>Bandwidth (Number of RBs)</th> <th>Setting range</th> <th>Default</th> </tr> </thead> <tbody> <tr> <td>1.4 MHz (6)</td> <td>3 to 6</td> <td>6</td> </tr> <tr> <td>3 MHz (15)</td> <td>3 to 8</td> <td>8</td> </tr> <tr> <td>5 MHz (25)</td> <td>3 to 13</td> <td>13</td> </tr> <tr> <td>10 MHz (50)</td> <td>3 to 17</td> <td>17</td> </tr> <tr> <td>15 MHz (75)</td> <td>3 to 19</td> <td>19</td> </tr> <tr> <td>20 MHz (100)</td> <td>3 to 25</td> <td>25</td> </tr> </tbody> </table>	Bandwidth (Number of RBs)	Setting range	Default	1.4 MHz (6)	3 to 6	6	3 MHz (15)	3 to 8	8	5 MHz (25)	3 to 13	13	10 MHz (50)	3 to 17	17	15 MHz (75)	3 to 19	19	20 MHz (100)	3 to 25	25
Bandwidth (Number of RBs)	Setting range	Default																					
1.4 MHz (6)	3 to 6	6																					
3 MHz (15)	3 to 8	8																					
5 MHz (25)	3 to 13	13																					
10 MHz (50)	3 to 17	17																					
15 MHz (75)	3 to 19	19																					
20 MHz (100)	3 to 25	25																					
Power Boosting	Set power boosting	-20.000 to +20.000 dB																					

MX370110A LTE TDD IQproducer MX370110A-001 LTE-Advanced TDD Option

Optional

MG3710A

Display	Outline	Setting Range
UL-SCH		
Transport Block Size	Sets transport block size of UL-SCH	0 to 86400
Data Type	Sets data type	PN9fix, PN15fix, 16bit repeat, User File
Data Type Repeat Data	Sets 16bit repeat data	0000 to FFFF (only when Data Type = 16bit repeat)
Data Type User File	Sets user file	Select any file (only when Data Type = User File)
RV Index	Sets redundancy version index	0, 1, 2, 3
HARQ-ACK		
Data Status	This enables or disables HARQ-ACK	Disable, Enable
Data Type	Sets the Data type to be inserted into the HARQ-ACK	ACK, NACK, ACK-ACK, ACK-NACK, NACK-ACK, NACK-NACK
Total Number of Coded Bits	Sets the number of bits after HARQ-ACK encoding	0 to Number of RBs × 288
RI		
Data Status	Enables or disables the RI	Disable, Enable
Data Type	Sets the Data type to be inserted into the RI	1 (1 bit), 2 (1 bit), 1 (2 bits), 2 (2 bits), 3 (2 bits), 4 (2 bits)
Total Number of Coded Bits	Sets the number of bits after RI encoding	0 to Number of RBs × 288
CQI/PMI		
Data Status	Enables or disables the CQI/PMI	Disable, Enable
Data Type	Sets the Data type to be inserted into the CQI/PMI	PN9fix, PN15fix, 16bit repeat, User File
Data Type Repeat Data	Sets the 16bit repeat data to be inserted into the CQI/PMI	0000 to FFFF (only when Data Type = 16bit repeat)
Data Type User File	Sets the User type to be inserted into the CQI/PMI	Select any file (only when Data Type = User File)
Total Number of Coded Bits	Sets the number of bits after CQI/PMI encoding	0 to 86400
Demodulation RS for PUSCH		
Group Hopping	Sets enable/disables	Disable, Enable
Sequence Hopping	Sets enable/disables	Disable, Enable
Delta ss	Sets delta ss	0 to 29
Base Sequence Group Number u	Sets base sequence group number	0 to 29
Base Sequence Number v	Displays base sequence number	0, 1
Cyclic Shift 1st slot		
n_cs	Sets n_cs of first slot of demodulation RS	0 to 11
alpha	Sets cyclic shift of first slot of demodulation RS	Alpha is calculated by the following expression. Five digits below the decimal are displayed. alpha = 2 π xixn_cs/12
Cyclic Shift 2nd slot		
n_cs	Sets n_cs of second slot of demodulation RS	0 to 11
alpha	Sets cyclic shift of second slot of demodulation RS	Alpha is calculated by the following expression. Five digits below the decimal are displayed. alpha = 2 π xixn_cs/12
PRACH		
PRACH Configuration	Sets the transmission timing for PRACH	The settable values for PRACH Configuration are determined according to Uplink-downlink Configuration as the table below. However, the setup of PRACH Configuration from 48 to 57 is only available in the following conditions: Cyclic Prefix is Normal and Special Subframe Configuration is from 5 to 8, or Cyclic Prefix is Extended and Special Subframe Configuration is from 4 to 6.
Uplink-downlink Configuration	Settable values for PRACH Configuration	0 0 to 10, 12 to 18, 20 to 57 1 0 to 7, 9 to 12, 15 to 39, 48 to 57 2 0 to 4, 6, 9, 10, 12, 15, 16, 18, 48 to 57 3 0 to 9, 12 to 18, 20, 21, 23, 25 to 31, 33, 35 to 41, 43, 45 to 49, 51, 53 to 57 4 0 to 4, 6, 9, 10, 12, 15, 16, 18, 20, 21, 23, 25 to 31, 33, 35 to 39, 48, 49, 51, 53 to 57 5 0, 1, 3, 6, 9, 12, 15, 18, 48, 49, 51, 53 to 57 6 0 to 15, 18 to 41, 43, 45 to 57
Number of PRACH Resources	Displays the number of PRACH Resources	Depending on the PRACH Configuration
PRACH Resource #0 to #5		
Data Status	Enables or disables the PRACH Resource #	Disable, Enable
Preamble Format	Displays the Preamble Format which decides the length in the time axis of PRACH Resource #	Depending on the PRACH Configuration
Frequency Resource Index	Displays Frequency Resource Index which decides the position in the frequency axis of PRACH Resource #	Depending on the PRACH Configuration, Uplink-downlink Configuration, PRACH Resource#
Transmit Frame	Displays Transmit Frame which decides the arrangement method of PRACH Resource# in the frame	Depending on the PRACH Configuration, Uplink-downlink Configuration, PRACH Resource#
Subframe Number	Displays the subframe number that PRACH Resource# transmits	Depending on the PRACH Configuration, Uplink-downlink Configuration, PRACH Resource#
Logical Root Sequence Number	Sets Logical Root Sequence Number that decides the value of Physical Root Sequence Number.	When Preamble Format is 0, 1, 2, 3: 0 to 837 When Preamble Format is 4: 0 to 137
Physical Root Sequence Number	Displays Physical Root Sequence Number used to calculate Cyclic Shift value	depending on the Logical Root Sequence Number
Cyclic Shift Set	Sets how to calculate Cyclic Shift value	Unrestricted, Restricted
v	Sets v value used to calculate Cyclic Shift value	0 to 63

MX370110A LTE TDD IQproducer

MX370110A-001 LTE-Advanced TDD Option

Optional

MG3710A

Display	Outline	Setting Range
Zero Correlation Zone Config	Sets Zero Correlation Zone Config used to calculate Cyclic Shift value	When Preamble Format is 0, 1, 2, 3 and Cyclic Shift Set is Unrestricted: 0 to 15 When Preamble Format is 0, 1, 2, 3 and Cyclic Shift Set is Restricted: 0 to 14 When Preamble Format is 4: 0 to 6
Cyclic Shift Value	Displays the Cyclic Shift Value	depending on the Cyclic Shift Set, v, Zero Correlation Zone Config, Logical Root Sequence Number.
Frequency Offset	Sets the Frequency Offset of the PRACH Resource #	When Bandwidth is 1.4 MHz 0 When Bandwidth is 3 MHz 0 to 9 When Bandwidth is 5 MHz 0 to 19 When Bandwidth is 10 MHz 0 to 44 When Bandwidth is 15 MHz 0 to 69 When Bandwidth is 20 MHz 0 to 94
Initial Power Boosting	Sets the initial power of PRACH Resource #	-10.000 to 10.000 [dB]
Power Ramping Step Size	Sets the amount of power to be increased each time a PRACH is transmitted	-10.000 to 10.000 [dB]

● Easy Setup Parameter Setting Range

Display	Setting Range
BS Test	
E-UTRA Test Models	E-TM1.1, E-TM1.2, E-TM2, E-TM2a, E-TM3.1, E-TM3.1a, E-TM3.2, E-TM3.3
FRC	FRC (QPSK, R = 1/3): A1-1, A1-2, A1-3, A1-4, A1-5 FRC (QPSK, R = 1/3): A3-1, A3-2, A3-3, A3-4, A3-5, A3-6, A3-7 FRC (16QAM, R = 2/3): A2-1, A2-2, A2-3 FRC (16QAM, R = 3/4): A4-1, A4-2, A4-3, A4-4, A4-5, A4-6, A4-7, A4-8 FRC (64QAM, R = 5/6): A5-1, A5-2, A5-3, A5-4, A5-5, A5-6, A5-7 FRC (Scenario 1): A7-1, A7-2, A7-3, A7-4, A7-5, A7-6 (except SRS Option) FRC (Scenario 2): A8-1, A8-2, A8-3, A8-4, A8-5, A8-6 (except SRS Option)

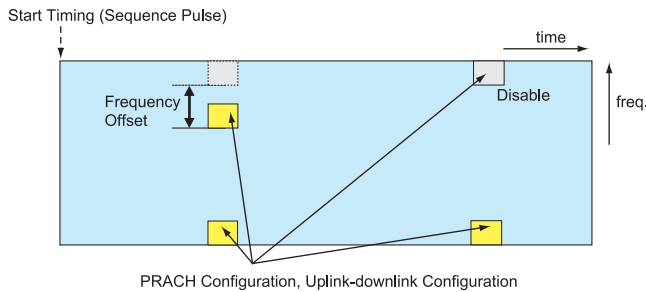

PRACH Parameters

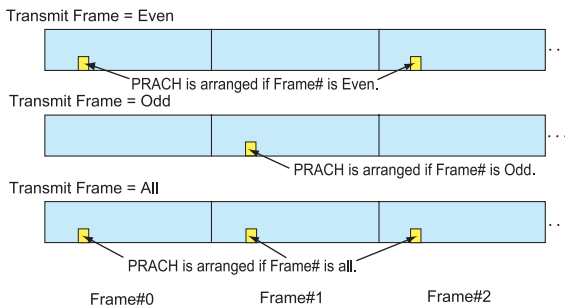

Configuration of PRACH Frame according to Transmit Frame

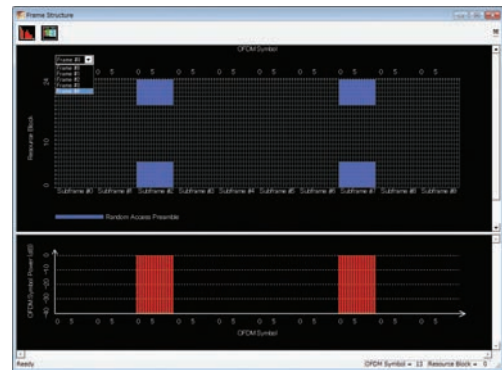

PRACH Parameter Settings

Common – Downlink/Uplink:	Uplink
Uplink – Transmission Type:	PRACH
Uplink – Uplink-downlink Configuration:	2
PRACH – Number of Frames:	5
PRACH – PRACH Configuration:	12

MX37011A WLAN IQproducer MX37011A-002 802.11ac (160 MHz) Option



Optional

MG3710A

The MX37011A WLAN IQproducer is PC application software with a GUI to generate IEEE Std 802.11-2007, IEEE Std 802.11n-2009 and IEEE802.11ac compliant waveform patterns. Installing the MX37011A-001 802.11ac (160 MHz) option supports output of signals in compliance with IEEE802.11ac standards.

WLAN IQproducer supports two setting screens: “Easy Setup Screen” and “Normal Setup Screen”.

Easy Setup Screen

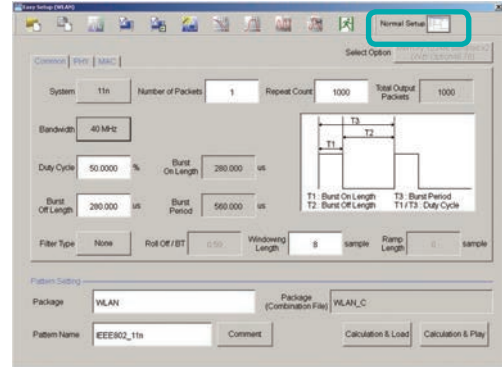

Normal Setup Screen

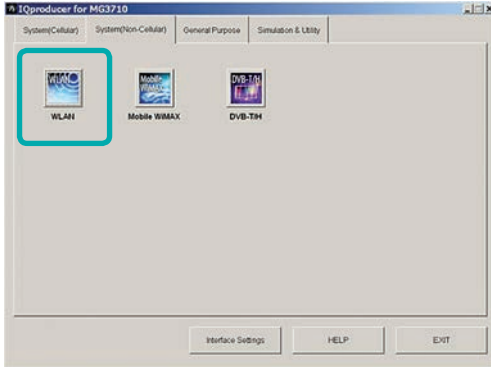
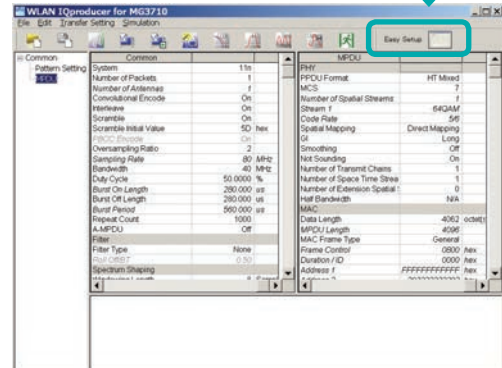

IQproducer Main Screen

- **Sample Parameter File**
MX37011A supports some sample parameter files. First, a sample parameter file is read (Recall), and detailed editing as necessary helps cut the parameter setting workload.

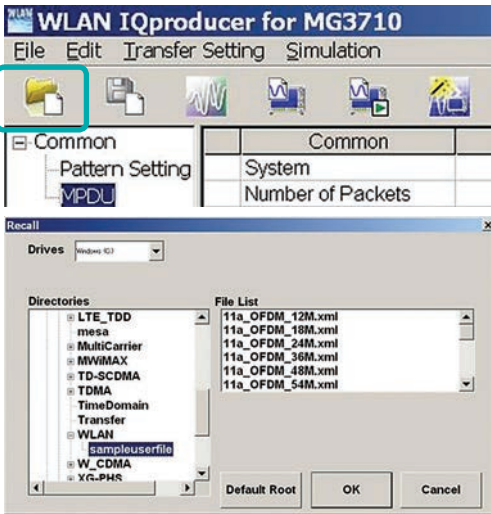

Parameter Recall Screen

MX37011A WLAN IQproducer MX37011A-002 802.11ac (160 MHz) Option

Optional

MG3710A

• Easy Setup Screen

Because it is limited to major parameters, it generates waveform patterns using simple operation. Moreover, touch-panel operation is supported when IQproducer is executed on the MG3710A. Use "Normal Setup function" for detailed parameter settings.

The screenshot shows the 'Easy Setup (WLAN)' interface. On the left, there are four smaller windows: 'System' (showing 11n selected), 'Bandwidth (System: 11n)' (showing 40 MHz selected), 'Bandwidth (System: 11ac)' (showing 80 MHz selected), and 'Filter Type' (showing 'None' selected). The main 'Easy Setup (WLAN)' window has the 'Common' tab selected. It shows 'System' as 11n, 'Number of Packets' as 1, and 'Repeat Count' as 1000. The 'Duty Cycle' is set to 50.0000%. A waveform diagram shows a burst with T1 (Burst On Length), T2 (Burst Off Length), and T3 (Burst Period). The 'Package' is set to WLAN and the 'Pattern Name' is IEEE802_11n.

Easy Setup Screen (Common Setup Screen)

*: PER (Packet Error Measurement), the number of waveform pattern packets is generated as [1] and the number of output times from the MG3710A main frame is set.
Example: Outputting 1000 packets
Number of Packets: 1
Repeat Count: 1000

Ex.) System:11n: PPDU Format: HT Mixed/HT Greenfield

The screenshot shows the 'PHY' setup screen for System:11n. The 'PPDU Format' is set to 'HT Mixed'. Other parameters include 'MCS' set to 7, 'Number of Spatial Streams' set to 1, and 'Stream1' set to '64QAM' with a 'Code Rate' of 5/6.

Ex.) System:11n: PPDU Format: Non-HT

The screenshot shows the 'PHY' setup screen for System:11n with 'PPDU Format' set to 'Non-HT'. Parameters include 'Data Rate' at 54 Mbps, 'Modulation' at 64QAM, and 'Code Rate' at 3/4.

Ex.) System: 11a/11b/11g/11j/11p

The screenshot shows the 'PHY' setup screen for System: 11a/11b/11g/11j/11p. Parameters include 'Data Rate' at 54 Mbps, 'Modulation' at 64QAM, and 'High Rate Modulation' set to 'Off'.

Ex.) System: 11ac

The screenshot shows the 'PHY' setup screen for System: 11ac. Parameters include 'PPDU Format' set to 'VHT', 'MCS' set to 8, and 'Modulation' set to 256QAM.

Easy Setup Screen (PHY Setup Screen)

The screenshot shows the 'MAC' setup screen. Parameters include 'Data Length' at 4052 Octets and 'MPDU Length' at 4096 Octets. Below, there are fields for 'Increment Sequence Number' (Off), 'Sequence Number' (1), and 'Increment Fragment Number' (Off). A 'Mac Frame Format' section shows 'Mac Frame Type' as 'General' and a table of control fields: Frame Control (On), Duration/ID (On), Address 1 (On), Address 2 (On), Address 3 (On), Seq Control (On), Address 4 (On), QoS Control (Off), HT Control (Off), Frame Body (On), and FCS (On).

Easy Setup Screen (MAC Setup Screen)

● Normal Setup Screen (IEEE 802.11a/b/g/n/j/p)

Sets system, number of packets in one waveform pattern, On/Off ratio (Duty) and filter at Common sheet. At PER (Packet Error Measurement), the number of waveform pattern packets is generated as [1] and the number of output times from the MG3710A main frame is set.

Example: Outputting 1000 packets
 Number of Packets: 1
 Repeat Count: 1000

Parameters displayed as tree. Add and delete A-MPDU. Pattern Setting, MPDU, A-MPDU

PHY/MAC parameter part displays selected MPDU and A-MPDU as tree.

All PHY parameters are the same value with MPDU and A-MPDU. Sets PPDU format, MCS, modulation method and data rate.

Common sets parameters, such as system, bandwidth, On/Off ratio, and filter. Setting pattern output count as "Repeat Count" supports simultaneous generation of sequence file (.wwi) and waveform pattern. This is used to limit number of packets output from SG for PER measurements.

MAC parameter supports different settings with MPDU and A-MPDU. Sets data length, MAC frame, address, etc.

Common		MPDU	
System	11n	PPDU Format	HT Greenfield
Number of Packets	1	MCS	50
Number of Antennas	3	Number of Spatial Streams	3
Convolutional Encode	On	Stream 1	64QAM
Interleave	On	Stream 2	16QAM
Scramble	On	Stream 3	16QAM
Scramble Initial Value	5D hex	Code Rate	3/4
PBCC Encode	On	Spatial Mapping	Direct Mapping
Oversampling Ratio	2	GI	Long
Sampling Rate	40 MHz	Smoothing	Off
Bandwidth	20 MHz	Not Sounding	On
Duty Cycle	50.0000 %	Number of Transmit Chains	3
Burst On Length	280.000 us	Number of Space Time Streams	3
Burst Off Length	280.000 us	Number of Extension Spatial Streams	0
Burst Period	560.000 us	Half Bandwidth	N/A
Repeat Count	1000	MAC	
A-MPDU	Off	Data Length	4062 octets
Filter		MPDU Length	4096
Filter Type	None	MAC Frame Type	General
Roll Off/BT	0.5	Frame Control	0800 hex
Spectrum Shaping		Duration / ID	0000 hex
Windowing Length	8 Samp	Address 1	FFFFFFFF hex
Ramp Length	8 Samp	Address 2	20222222202 hex
		Address 3	50555555505 hex
		Sequence Control	0000 hex

WLAN IQproducer Setting Screen

MX370111A WLAN IQproducer MX370111A-002 802.11ac (160 MHz) Option

Optional

MG3710A

● System Setting

Selects and sets System.

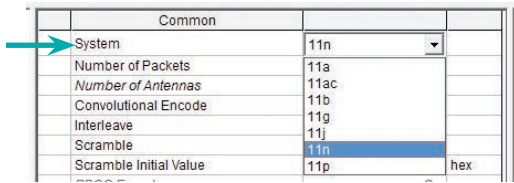

● Duty Cycle Setting

Sets burst On/Off ratio according to Rx test conditions. Sets Duty Cycle and Burst Off Length. Burst On Length is decided by Data Length settings of MAC parameter. Burst Period is decided by Duty Cycle and Burst Off Length settings.

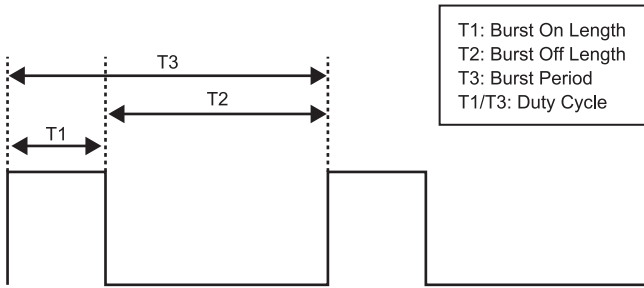
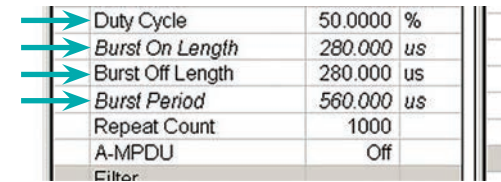

Burst On/Off Setting Image

● MAC Frame Type Selection

Clicking MAC Frame Type "General" displays MAC Frame format setting screen to set address information. Match address of Rx equipment for Rx tests.

● PDU Format Selection for IEEE802.11n Signals

Selects and sets following for IEEE802.11n signals:

- PDU format: Non-HT, HT Mixed, HT Greenfield
- MCS: 0 to 76

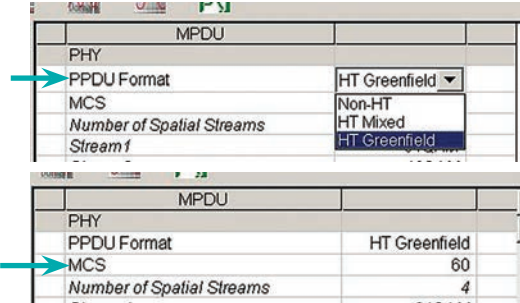

● Filter Selection

Sets waveform pattern filter conditions for system or Rx specifications.

- None, Gaussian, Root Nyquist, Nyquist, Ideal

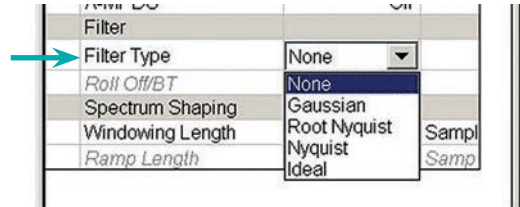

● Increment Selection

Select On/Off matching Rx test conditions.

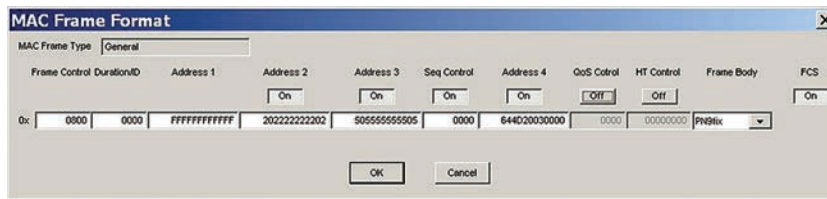
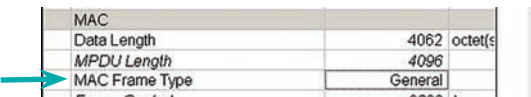
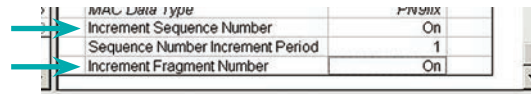

• Normal Setup Screen

This screen sets common settings, such as user mode (Single User/Multi User), bandwidth, number of packets in one waveform pattern, On/Off ratio (Duty), filter, and PHY/MAC parameters.

Displays MPDU/A-MPDU in tree for each user #. User/MPDU/A-MPDU can be added and deleted. Pattern Setting, User #0 to #3 MPDU, A-MPDU.

Common sets parameters, such as User Mode (Single User/Multi User), bandwidth, On/Off ratio, and filter. Setting pattern output count as "Repeat Count" supports simultaneous generation of sequence file (.wwi) and waveform pattern. This is used to limit number of packets output from SG for PER measurements.

Displays MPDU and A-MPDU for selected user# for PHY/MAC parameter.

Each user# PHY parameter becomes same value at all MPDU, and A-MPDU. Sets MCS, modulation method, etc.

Different value can be set for each user# MAC parameter at MPDU, A-MPDU. Sets data length, MAC frame, address, etc.

Common		User#0 (MPDU)	
System	11ac	PHY	Scramble On
Number of Packets	1	MCS	8
Number of Antennas	2	Number of Spatial Streams	1
Total Output Packets	1000	Modulation	256QAM
Oversampling Ratio	-	Code Rate	3/4
Sampling Rate	200 MHz	Coding Mode	BCC
Bandwidth	160 MHz	Coding	On
Duty Cycle	50.0000 %	BCC Interleaver	On
Burst On Length	92.000 us	LDPC Tone Mapper	On
Burst Off Length	92.000 us	Number of Space Time Streams	1
Burst Period	184.000 us	Group ID	01 hex
Repeat Count	1000	Partial AID	000 hex
Scramble Initial Value	5D hex	TXOP PS NOT ALLOWED	1
Filter	None	MAC	A-MPDU Off
Filter Type	None	Data Length	4062 oct
Roll Off/BT	0.50	MPDU Length	4096
Spectrum Shaping	-	Total A-MPDU Length	0
Windowing Length	8 Samples	MAC Frame Type	General
IEEE 802.11ac		Frame Control	0800 hex
PPDU Format	VHT	Duration / ID	0000 hex
User Mode	Multi User	Address 1	FFFFFFFFFFFF hex
Number of Transmit Chains	2	Address 2	202222222202 hex
Spatial Mapping	Spatial Expansion	Address 3	505555555505 hex
GI	Long	Sequence Control	0000 hex
Total Number Of Space Time	2		

• Selects Bandwidth

Selects and sets following
20 MHz, 40 MHz, 80 MHz, 160 MHz, 80+80 MHz

Bandwidth	160	MHz
Duty Cycle	20	%
Burst On Length	40	us
Burst Off Length	80	us
Burst Period	160	us
Repeat Count	80+80	

• PPDU format

Fixes PPDU format to "VHT".

IEEE 802.11ac		VHT
PPDU Format		VHT

• Selects User Mode

Selects and sets Single User/Multi User.
Sets up to four users from #0 to #3 at Multi User setting.

IEEE 802.11ac		VHT
PPDU Format		VHT
User Mode	Multi User	
Number of Transmit Chains	Single User	
Spatial Mapping	Multi User	

• Sets Number of Transmit Chain

Setting range: 1 to 8

IEEE 802.11ac		VHT
PPDU Format		VHT
User Mode	Single User	
Number of Transmit Chains	8	

• Sets MCS

Setting range: 0 to 9
Sets modulation method according to MCS setting.

PHY		
Scramble		On
MCS	8	
Number of Spatial Streams		1
Modulation		256QAM
Code Rate		5/6

MX370111A WLAN IQproducer MX370111A-002 802.11ac (160 MHz) Option

Optional

MG3710A

- MG3710A Vector Signal Generator – One Unit Supports All Bandwidth Configurations for IEEE802.11ac Signals. The MG3710A supports a built-in baseband signal generator with an upper frequency limit of 6 GHz and an RF modulation bandwidth of 160 as well as up to two RF output connectors*1. It enables one unit to support all bandwidth configurations for IEEE802.11ac signals.

Calculation & Play Function*2

After waveform generation is completed, the generated pattern is loaded into memory, selected and output from the MG3710A. When the IEEE802.11ac signal bandwidth is set to “80 MHz + 80 MHz”, the Calculation & Play function is used to load the waveforms simultaneously to the RF outputs (SG1/SG2) of the MG3710A in which two RF outputs have been installed.

*1: With MG3710A-062 (2.7 GHz)/064 (4 GHz)/066 (6 GHz) 2ndRF Option.
*2: This software is enabled only when used on the MG3710A.

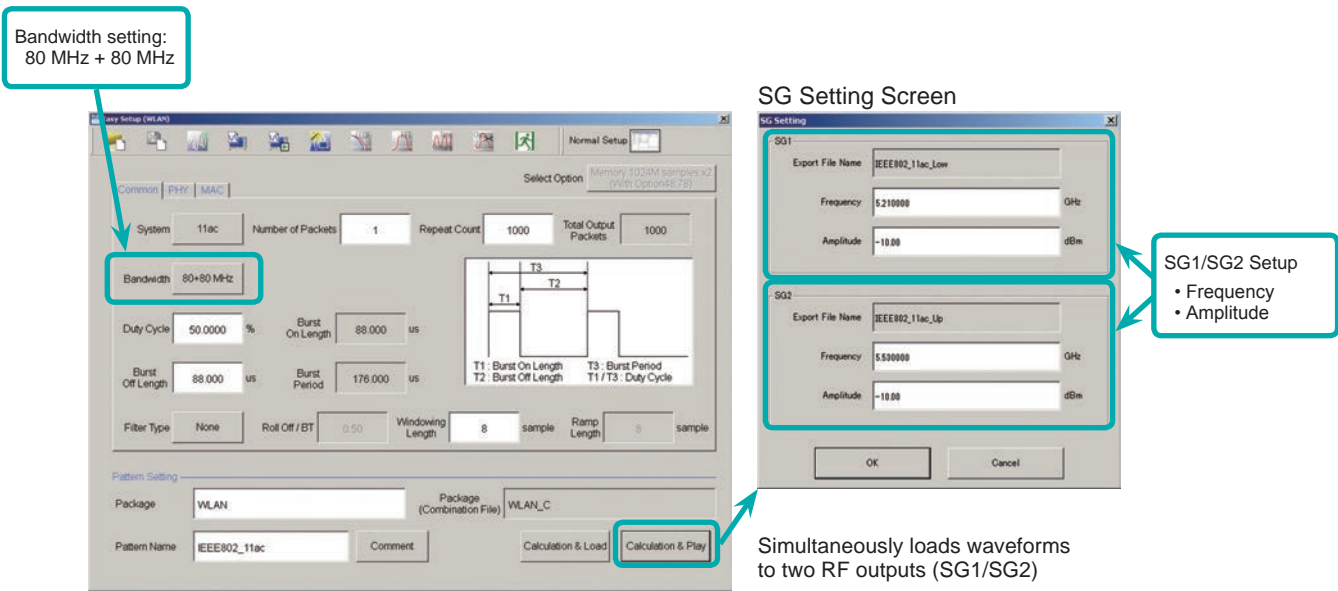

- Supported Vector Signal Generator Series IEEE802.11ac Signal Bandwidth

IEEE802.11ac Signal Bandwidth	Vector Signal Generator Series		Vector Signal Generator Option for Signal Analyzer	
	MG3710A*1	MG3700A*2	MS2690A series Opt. 020*3	MS2830A Opt. 020/021*3
20 MHz/40 MHz/80 MHz	✓ (1 unit)	✓ (1 unit)	✓ (1 unit)	✓ (1 unit)
160 MHz	✓ (1 unit)	—	—	—
80 MHz + 80 MHz (non-contiguous)	✓ (2 RF 1 unit*4, or 1 RF 2 units)	✓ (2 units)	✓ (2 units)	✓ (2 units)

*1: MX370111A WLAN IQproducer and MX370111A-002 802.11ac (160 MHz) Option installed.
*2: MX370111A WLAN IQproducer and MX370111A-001 802.11ac (80 MHz) Option installed.
*3: MX269911A WLAN IQproducer and MX269911A-001 802.11ac (80 MHz) Option installed.
*4: MG3710A-062 (2.7 GHz)/064 (4 GHz)/066 (6 GHz) 2ndRF Option installed.

Easy Setup Screen

● Common Parameter Setting Range

Display	Outline	Setting Range
Common		
System	Sets the system	11a, 11ac, 11b, 11g, 11j, 11n, 11p
Number of Packets	Sets the number of packets to be generated	1 to the maximum number of packets for the waveform memory
Repeat Count	Sets the repeat count of packet to be transmitted	1 to 65535 The setting is void if MS269x or MS2830 is selected in the Select instrument dialog box
Total Output Packets	Displays the total number of packets (Number of Packets × Repeat Count)	
Bandwidth	Sets the bandwidth	System = 11a/11j: 20 MHz System = 11n: 20 MHz or 40 MHz System = 11p: 10 MHz System = 11ac: 20, 40, 80, 160, 80 + 80 MHz *160 MHz is not settable if MG3700A/MS2830A/MS269xA is selected in the Select instrument dialog box. Not available when System = 11b, 11g
Duty Cycle	Sets the On/Off ratio of the burst signal	0.1000 to 99.0000 [%] When setting Duty Cycle, Burst Off Length and Burst Period are automatically calculated. Also, when Burst On Length or Burst Off Length is changed, Duty Cycle is automatically calculated
Burst On Length	Displays the burst on length [us]	Displays the calculated value The calculated result is rounded to a multiple of 1/Sampling Rate [μs]
Burst Off Length	Sets the burst off length [us]	The setting range is decided by the maximum and minimum values of Duty Cycle and the calculated value of Burst On Length
Burst Period	Display the burst period [us]	Displays the calculated value
Filter Type	Sets the filter type	None, Gaussian, Root Nyquist, Nyquist, Ideal
Roll Off/BT	Sets the roll-off factor or BT product	0.1 to 1.00 (The setting is fixed when Filter Type is set to Ideal or None)
Windowing Length	Sets the windowing length	0 to 32 × Oversampling Rate: Available in the following conditions: System = 11a, 11j, 11p, 11n, 11ac System = 11g, and Frame Format = ERP-OFDM, DSSS-OFDM
Ramp Length	Sets the ramp length	0 to 16 × Oversampling Rate: Available in the following conditions: System = 11b System = 11g, and Frame Format = ERP-DSSS, ERP-CCK, ERP-PBCC

● PHY Parameter Setting Range

Display	Outline	Setting Range
PPDU Format	Sets the PPDU Format	System = 11n: Non-HT, HT-Mixed, and HT-Greenfield System = 11ac: VHT
MCS	Sets the MCS	System = 11n: 0 to 7 System = 11ac: 0 to 9 Available in the following conditions: System = 11n, and PPDU Format = HT Mixed, or HT Greenfield, or System = 11ac
Number of Spatial Streams	Sets the number of streams	
Data Rate	Sets the data rate	1, 2, 3, 4.5, 5.5, 6, 9, 11, 12, 18, 22, 24, 27, 33, 36, 48, 54 Not available in the following conditions: System = 11n, and PPDU Format = HT Mixed or HT Greenfield, or System = 11ac
Modulation	Displays the PSDU modulation method	BPSK, QPSK, 16QAM, 64QAM, DBPSK, DQPSK: Not available in the following conditions: System = 11b and Data Rate = 5.5, 11 Mbps System = 11g and Data Rate = 5.5, 11, 22, 33 Mbps System = 11n and PPDU Format = HT Mixed or HT Greenfield
High Rate Modulation	Sets the modulation method for direct sequence spread spectrum	CCK, PBCC: Available in the following conditions: System = 11b System = 11g and Frame Format = ERP-CCK, ERP-PBCC CCK, PBCC is selectable when Data Rate = 5.5 Mbps, 11 Mbps Only PBCC can be set when Data Rate = 22 Mbps, 33 Mbps
Code Rate	Displays the coding rate	1/2, 2/3, 3/4, 5/6 Not available in the following conditions: System = 11b System = 11g, and Data Rate = 1, 2, 5.5, 11, 22, 33 Mbps.
Preamble Type	Sets the preamble type	Long, Short: Available in the following conditions: System = 11b, System = 11g (Only Long can be set when System = 11g, Frame Format = ERP-DSSS, Data Rate = 1 Mbps) (Only Long can be set when System = 11g, and Frame Format = ERP-OFDM) (Only Long can be set when System = 11b, and Data Rate = 1 Mbps)
Frame Format	Sets the secondary modulation method for header and payload	ERP-OFDM, DSSS-OFDM, ERP-DSSS, ERP-CCK, ERP-PBCC: Available in the following conditions: System = 11g
GI	Sets the guard interval length	Short, Long: Available in the following conditions: System = 11n and PPDU Format = HT Mixed, or HT Greenfield or System = 11ac
Coding Mode	Sets the coding mode	This function can be set in the following cases: System = 11ac

MX370111A WLAN IQproducer

MX370111A-002 802.11ac (160 MHz) Option

Optional

MG3710A

• MAC Parameter Setting Range

Display	Outline	Setting Range
Data Length	Sets the data length	System = 11a, 11b, 11g, 11j, 11p, or System = 11n and PPDU format = Non-HT: 1 to (4095-Diff) System = 11n, and PPDU Format = HT Mixed, or HT Greenfield: 1 to (65535-Diff) System = 11ac: 1 to (65535-Diff) Diff = Total Length (Mac Header + FCS) – (Sum of the MAC parameters set to Off in the Frame Format setting screen [octet(s)]) Total Length = 40 [octet(s)]
MPDU Length	Displays the MPDU length	System = 11a, 11b, 11g, 11j, 11p, or System = 11n and PPDU format = Non-HT: (Diff + 1) to 4095 System = 11n, and PPDU Format = HT Mixed, or HT Greenfield: (Diff+1) to 65535 System = 11n, and A-MPDU = ON: (Diff + 1) to 4095 System = 11ac: (Diff+1) to 65535 [octet(s)]
MAC Data Type	Sets the type of data assigned to the MAC frame body	PN9fix, PN15fix, 16bit repeat, User File
Frame Control	Sets the frame control	0x0000 to 0xFFFF
Duration/ID	Sets the Duration/ID	0x0000 to 0xFFFF
Address1/2/3/4	Sets the MAC Address1/2/3/4	0x0000 0000 0000 to 0xFFFF FFFF FFFF
Sequence Control	Sets the Sequence Control	0x0000 to 0xFFFF
QoS Control	Sets the QoS Control	0x0000 to 0xFFFF
HT Control	Sets the HT Control	0x0000 0000 to 0xFFFF FFFF
Increment Sequence Number	Sets whether to increment the sequence number	On, Off If set to On, the count-up operation starts from the upper 12 bits of the value specified for Sequence Control, incrementally at each interval specified by Sequence Number Increment Period
Sequence Number Increment Period	Sets the interval to increment the sequence number	1 to 15: This is available when Increment Sequence Number is set to On
Increment Fragment Number	Sets whether to increment the Fragment Number	On, Off If set to On, the count-up operation starts from the lower 4 bits of the value specified for Sequence Control, incrementally for each frame at each interval specified by Sequence Number Increment Period
FCS	Sets whether to enable the MAC checksum function	On, Off

Normal Setup Screen

• Common Parameter Setting Range

Display	Outline	Setting Range
Common		
System	Sets System standard	11a, 11ac, 11b, 11g, 11j, 11n, 11p

• Common Parameter Setting Range (System = other than 11ac)

Display	Outline	Setting Range
Common		
Number of Packets	Sets the number of packets to be generated	1 to the maximum capacity of waveform memory
Number of Antennas	Displays the number of antennas	1 to 4: Displays the value of Number of Transmit Chains in the following conditions: System = 11n, and PPDU Format = HT Mixed, or HT Greenfield The setting is fixed to 1 when the System is other than 11n.
Convolutional Encode	Enables/Disables convolutional encoding	On, Off
Interleave	Enables/Disables interleave processing	On, Off: This is available in the following conditions: System = 11a, 11j, 11n, 11p, System = 11g, and Frame Format = DSSS-OFDM/ERP-OFDM
Scramble	Enables/Disables scramble processing	On, Off
Scramble Initial Value	Sets the initial value of scramble processing	0x00 to 0x7F: Available only for System = 11a, 11n
PBCC Encode	Enables/Disables PBCC encoding	On, Off: This is available in the following conditions: System = 11b and High Rate Modulation = PBCC System = 11g and Frame Format = ERP-PBCC
Oversampling Ratio	Sets oversampling ratio	The setting range for each system is as follows: System = 11b: 4, 8 System = 11a, 11g, 11j, 11n, 11p: 2, 4, 8 System = 11g, Data Rate = 1, 2, 5.5, 11, 22, 33 Mbps: 4, 8 Note, however, that the setting range is 2 and 4 if System = 11n and Bandwidth = 40 MHz
Sampling Rate	Displays the sampling rate	System = 11a: 20 MHz × Oversampling Ratio System = 11b: 11 MHz × Oversampling Ratio System = 11g, Data Rate = 1, 2, 5.5, 11 Mbps: 11 MHz × Oversampling Ratio System = 11g, Data Rate = other than 1, 2, 5.5, 11 Mbps: 20 MHz × Oversampling Ratio System = 11j: 20 MHz × Oversampling Ratio System = 11n, Bandwidth = 20 MHz: 20 MHz × Oversampling Ratio System = 11n, Bandwidth = 40 MHz: 40 MHz × Oversampling Ratio System = 11p: 10 MHz × Oversampling Ratio
Bandwidth	Set bandwidth	System = 11p: 10 MHz System = 11a/11j: 20 MHz System = 11n: 20 MHz or 40 MHz Not available when System = 11b, 11g
Duty Cycle	Sets the On/Off ratio of the burst signal	0.1000 to 99.0000% When Duty Cycle is set, Burst Off Length and Burst Period is automatically calculated. When Burst On Length and Burst Off Length is changed, Duty Cycle is automatically calculated
Burst On Length	Displays Burst On Length [μs]	Displays the calculated value. The calculated result is rounded to a multiple of 1/Sampling Rate [μs]

MX370111A WLAN IQproducer MX370111A-002 802.11ac (160 MHz) Option

Optional

MG3710A

Display	Outline	Setting Range
Burst Off Length	Displays Burst Off Length [μs]	The setting range is decided by the maximum and minimum values of Duty Cycle and the calculated value of Burst On Length. When setting Burst Off Length, Duty Cycle and Burst Period are automatically calculated. Also, Burst Off Length is calculated from the values of Duty Cycle and Burst On Length as below. Burst Off Length = Burst On Length × (100.0 – Duty Cycle)/Duty Cycle
Burst Period	Displays Burst Period [μs]	Displays the calculated value
Repeat Count	Sets the repeat count of packet to be transmitted	1 to 65535 This setting is void if MS269x or MS2830 is selected in the Select instrument dialog box
A-MPDU	Enables/Disables A-MPDU	On, Off: Available in the following conditions: System = 11n and PPDU Format = HT Mixed, or HT Greenfield
Filter		
Filter Type	Sets the filter type	None, Gaussian, Root Nyquist, Nyquist, Ideal
Roll Off/BT	Sets the roll-off factor or BT product	0.01 to 1.00 (The setting is not available when Filter Type is set to Ideal or None)
Spectrum Shaping		
Windowing Length	Sets the windowing length	0 to 32 × Oversampling Rate: Available in the following conditions: System = 11a, 11j, 11p, 11n System = 11g, and when Frame Format is ERP-OFDM/DSSS-OFDM
Ramp Length	Sets the ramp length	0 to 16 × Oversampling Rate: Available in the following conditions: System = 11b System = 11g, and when Frame Format is ERP-DSSS/ERP-CCK/ERP-PBCC

● Common Parameter Setting Range (System = 11ac)

Display	Outline	Setting Range
Common		
Number of Packets	Sets the number of packets to be generated	1 to the maximum capacity of waveform memory
Number of Antennas	Displays the number of antennas	1 to 8
Total Output Packets	Displays the total number of packets (Number of Packets×Repeat Count)	
Oversampling Ratio	Sets the oversampling ratio	2, 4, 8 Bandwidth = 40 MHz: 2, 4 Bandwidth = 80 MHz/80 + 80 MHz: 2 only. Bandwidth = 160 MHz: invalid.
Sampling Rate	Displays sampling rate	Bandwidth MHz × Oversampling Ratio When the bandwidth is 160 MHz, the sampling rate is fixed to 200 MHz
Bandwidth	Sets the bandwidth	20, 40, 80, 160, 80 + 80 MHz 160 MHz is not settable if MG3700A, MS269x, or MS2830 is selected in the Select instrument dialog box
Duty Cycle	Sets the On/Off ratio of the burst signal	0.1000 to 99.0000 [%] When setting Duty Cycle, Burst Off Length and Burst Period are automatically calculated. Also, when Burst On Length or Burst Off Length is changed, Duty Cycle is automatically calculated
Burst On Length	Displays Burst On Length [μs]	Displays the calculated value (The calculated result is rounded to a multiple of 1/ Sampling Rate [μs])
Burst Off Length	Displays Burst Off Length [μs]	The setting range is decided by the maximum and minimum values of Duty Cycle and the calculated value of Burst On Length. When setting Burst Off Length, Duty Cycle and Burst Period are automatically calculated. Also, Burst Off Length is calculated from the values of Duty Cycle and Burst On Length as below. Burst Off Length = Burst On Length × (100.0 – Duty Cycle)/Duty Cycle
Burst Period	Displays the burst period [μs]	Displays the calculated value
Repeat Count	Sets the repeat count of packet to be transmitted	1 to 65535 The setting is void if MS269x or MS2830 is selected in the Select instrument dialog box
Scramble Initial Value	Sets the initial value of scramble processing	0x00 to 0x7F
Filter		
Filter Type	Sets the filter type	None, Gaussian, Root Nyquist, Nyquist, Ideal
Roll Off/BT	Sets the roll-off factor or BT product	0.01 to 1.00 (The setting is not available when Filter Type is set to Ideal or None)
Spectrum Shaping		
Windowing Length	Sets the windowing length	0 to 32 × Oversampling Rate The setting range is 0 to 32 when the bandwidth is 160 MHz
IEEE 802.11ac		
PPDU Format	Displays the PPDU format	VHT
User Mode	Sets the user mode	Single User, Multi User
Number of Transmit Chains	Sets the number of transmit chain	1 to 8 Number of Transmit Chains cannot be set to equal to or under Total Number of Space Time Streams
Spatial Mapping	Sets the spatial mapping	Direct Mapping, Spatial Expansion, Edit Mode This function can be used in the following cases: Direct Mapping is available only when Number of Space Time Streams matches Number of Transmit Chains. When Number of Transmit Chains is 1, only Direct Mapping is available
Edit Mode	Sets the value of Spatial Mapping Matrix	–1.00000 – j1.00000 to 1.00000 + j1.00000 The setting resolution is 0.00001 for both real and imaginary parts
Spatial Mapping Matrix	Sets the Spatial Mapping	Number of Transmit Chains: 1 to 8 Total Number of Space Time Streams: 1 to 8
GI	Sets the guard interval	Short, Long
Total Number of Space Time Streams	Displays the total number of space time stream	1 to 8 Displays the total number of space time streams under each User#

MX370111A WLAN IQproducer MX370111A-002 802.11ac (160 MHz) Option

Optional

MG3710A

● PHY Parameter Setting Range (System = other than 11ac)

Display	Outline	Setting Range
PPDU Format	Sets the PPDU format	Non-HT, HT Mixed, HT Greenfield: Available in the following conditions: System = 11n
MCS	Sets the MCS	0 to 76: Available in the following conditions: System = 11n and PPDU Format = HT Mixed, or HT Greenfield Details about the parameters when MCS is set are defined in IEEE 802.11n-2009 20.6
Number of Spatial Streams	Displays the number of spatial streams	1 to 4: Available in the following conditions: System = 11n and PPDU Format = HT Mixed, or HT Greenfield The displayed value varies according to MCS
High Rate Modulation	Sets the modulation scheme during direct diffusion	CCK, PBCC: Available in the following conditions: System = 11b System = 11g, and Frame Format = ERP-CCK, ERP-PBCC CCK, PBCC is selectable when Data Rate = 5.5 Mbps, 11 Mbps. Only PBCC can be set when Data Rate = 22 Mbps, 33 Mbps
Modulation	Displays the PSDU modulation scheme	BPSK, QPSK, 16QAM, 64QAM, DBPSK, DQPSK: Not available in the following conditions: System = 11b and Data Rate = 5.5, 11 Mbps System = 11g and Data Rate = 5.5, 11, 22, 33 Mbps System = 11n and PPDU Format = HT Mixed, or HT Greenfield
Code Rate	Displays the code rate	1/2, 2/3, 3/4, 5/6 System = 11b System = 11g, and Data Rate = 1, 2, 5.5, 11, 22, 33 Mbps. Display only when System = 11n and PPDU Format = HT Mixed, or HT Greenfield
Data Rate	Sets the data rate	1, 2, 3, 4.5, 5.5, 6, 9, 11, 12, 18, 22, 24, 27, 33, 36, 48, 54 This setting is not available in the following conditions: System = 11n and PPDU Format = HT Mixed, or HT Greenfield
Preamble Type	Sets the preamble type	Long, Short: Available in the following conditions: System = 11b, System = 11g (Only Long can be set when System = 11g, Frame Format = ERP-DSSS, Data Rate = 1 Mbps) (Only Long can be set when System = 11g, and Frame Format = ERP-OFDM) (Only Long can be set when System = 11b, and Data Rate = 1 Mbps)
Frame Format	Sets the secondary modulation scheme of the header and payload	ERP-OFDM, DSSS-OFDM, ERP-DSSS, ERP-CCK, ERP-PBCC: Available in the following conditions: System = 11g
Spatial Mapping	Sets the spatial mapping mode	Direct Mapping, Spatial Expansion, Edit Mode: Available in the following conditions: System = 11n and PPDU Format = HT Mixed, or HT Greenfield (Direct Mapping is available only when: Number of Space Time Streams = Number of Transmit Chains) (Direct Mapping can be set only when: Number of Transmit Chains = 1)
Edit Mode	Sets spatial mapping matrix	-1.00000-j1.00000 to 1.00000+j1.00000 The setting resolution is 0.00001 for both real and imaginary parts
Spatial Mapping Matrix	Extends the stream from space time stream to transmit chains	Number of Transmit Chains 1 to 4 Number of Space Time Streams 1 to 3
GI	Sets the guard interval	Short, Long: Available in the following conditions: System = 11n and PPDU Format = HT Mixed, or HT Greenfield
Smoothing	Enables/Disables smoothing processing	On, Off: Available in the following conditions: System = 11n and PPDU Format = HT Mixed, or HT Greenfield
Not Sounding	Enables/Disables not sounding processing	On, Off: Available in the following conditions: System = 11n and PPDU Format = HT Mixed, or HT Greenfield
Number of Transmit Chains	Sets number of transmit chains	1 to 4: Available in the following conditions: System = 11n and PPDU Format = HT Mixed, or HT Greenfield A value equal to or greater than that set for Number of Space Time Streams can be set for Number of Transmit Chains
Number of Space Time Streams	Sets the number of space time streams	1 to 4: Available in the following conditions: System = 11n and PPDU Format = HT Mixed, or HT Greenfield A value equal to or greater than that set for Number of Spatial Streams can be set for Number of Space Time Streams
Number of Extension Spatial Streams	Sets number of extension spatial streams	0 to (Number of Transmit Chains-Number of Space Time Streams): Available in the following conditions: System = 11n and PPDU Format = HT Mixed, or HT Greenfield
Half Bandwidth	Sets the carrier arrangement when bandwidth = 40 MHz	Lower Mode, Upper Mode, N/A: This is available only when System = 11n and Bandwidth = 40 MHz (Only N/A can be set when in MCS32) (Only the lower 20 MHz of a 40 MHz channel is transmitted when Lower Mode is specified. N/A transmits 40 MHz channel as is) (Only the upper 20 MHz of a 40 MHz channel is transmitted when Upper Mode is specified. N/A transmits 40 MHz channel as is)

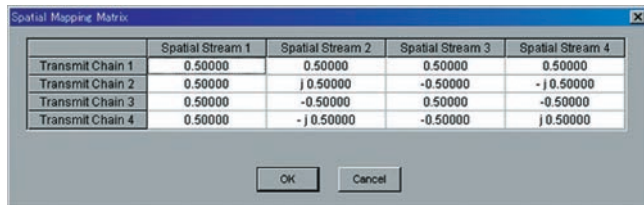

Edit Mode in Spatial Mapping

System = 11ac, System = 11n, PPDU Format = HT Mixed or HT Greenfield,
Can be set when Spatial Mapping = Edit Mode.

● PHY Parameter Setting Range (System = 11ac)

Display	Outline	Setting Range
Scramble	Enables/disables scramble processing	On, Off
MCS	Sets the MCS	0 to 9
Number of Spatial Streams	Sets the number of spatial streams	1 to 8 The setting range is 1 to 4 when the user mode is Multi User
Modulation	Displays the modulation scheme of PSDU	BPSK, QPSK, 16QAM, 64QAM, 256QAM The value depends on MCS
Code Rate	Displays the code rate	1/2, 2/3, 3/4, 5/6 The value depends on MCS
Coding	Sets of the coding is On or Off	Fixed to On for System = 11ac
Coding Mode	Sets the coding mode	Fixed to BCC for System = 11ac
BCC Interleaver	Enables/disables BCC Interleaver	Fixed to On for System = 11ac
LDPC Tone Mapper	Enables/disables LDPC Tone Mapper	On, Off Void for System = 11ac
Number of Space Time Streams	Sets the number of space time stream	The same value as Number of Spatial Stream, Number of Spatial Stream × 2 Number of Spatial Streams × 2 is settable only when Number of Spatial Streams × 2 ≤ Number of Transmit Chains. When the user mode is set to Multi User, Number of Spatial Streams × 2 is not settable unless Number of Spatial Streams ≤ 2 for each User#
Group ID	Sets the group ID	0x00, 0x3F (User Mode = Single User) 0x01 to 0x3E (User Mode = Multi User)
Partial AID	Sets Partial AID	0x000 to 0x1FF Void when User Mode = Multi User
TXOP PS NOT ALLOWED	Sets TXOP PS NOT ALLOWED	0, 1

● MAC Parameter Setting Range (System = other than 11ac)

Display	Outline	Setting Range
Data Length	Sets the data wavelength	System = 11a, 11b, 11g, 11j, 11p, or System = 11n and PPDU format = Non-HT: 1 to (4095-Diff) System = 11n, and PPDU Format = HT Mixed, or HT Greenfield: 1 to (65535-Diff) Diff refers to a value (octets) obtained by subtracting the value of Total Length (MAC header + FCS) from the total number of MAC parameters that are set to Off in the MAC Frame Format setting window. Total Length = 40 [octet (s)]
MPDU Length	Displays the MPDU length	System = 11a, 11b, 11g, 11j, 11p, or System = 11n and PPDU format = Non-HT: (Diff+1) to 4095 System = 11n, and PPDU Format = HT Mixed, or HT Greenfield: (Diff+1) to 65535 System = 11n, and A-MPDU = ON: (Diff+1) to 4095
MAC Frame Type	Sets the MAC Frame type	MAC information can be set (See diagram below)
MAC Data Type	Displays the type of data assigned to the MAC frame body	PN9fix, PN15fix, 16bit repeat, User File
Data Type Repeat Data	Sets 16-bit data to be assigned to the MAC frame body	0x0000 to 0xFFFF (This parameter is displayed only when 16 bit repeat is selected for MAC Data Type)
Data Type User File	Sets a user file to be assigned to the MAC frame body	Any file can be selected (This parameter is displayed only when User File is selected for MAC Data Type)
Frame Control	Sets the frame control	0x0000 to 0xFFFF
Duration/ID	Sets the Duration/ID	0x0000 to 0xFFFF
Address1/2/3/4	Sets the address1/2/3/4	0x0000 0000 0000 to 0xFFFF FFFF FFFF
Sequence Control	Sets the sequence control	0x0000 to 0xFFFF
QoS Control	Sets the QoS control	0x0000 to 0xFFFF
HT Control	Sets the HT control	0x0000 0000 to 0xFFFF FFFF
MAC FCS	Enables/Disables the MAC FCS	On, Off
Increment Sequence Number	Enables/Disables the Increment sequence number	On, Off If set to On, the count-up operation starts from the upper 12 bits of the value specified for Sequence Control, incrementally at each interval specified by Sequence Number Increment Period
Sequence Number Increment Period	Sets the interval to count up the sequence number	1 to 15: This is available when Increment Sequence Number is set to On
Increment Fragment Number	Enables/Disables the Increment fragment number	On, Off If set to On, the count-up operation starts from the lower 4 bits of the value specified for Sequence Control, incrementally for each packet at each interval specified by Sequence Number Increment Period

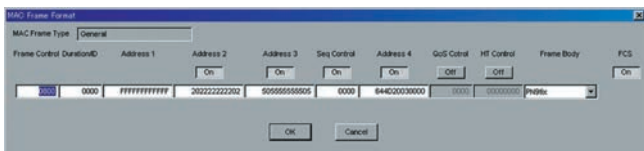

MAC Frame Format Setting Screen

Opened by double-clicking MAC Frame Type [General] on MAC parameter setting screen

MX370111A WLAN IQproducer

MX370111A-002 802.11ac (160 MHz) Option

Optional

MG3710A

• MAC Parameter Setting Range (System = 11ac)

Display	Outline	Setting Range
A-MPDU	Enables/disables A-MPDU for each User#	On, Off If A-MPDU is set to Off in one A-MPDU#, all MPDU/A-MPDU# under other User#s are all set to Off
Data Length	Set the data length	1 to (65535 – Diff) (A-MPDU = Off) 1 to (16384 – Diff) (A-MPDU = On) Diff = Total Length(Mac Header + FCS) – (Sum of MAC parameters [octet(s)] that are Off on MAC Frame Format setting window.) Total Length = 40 [octet(s)]
MPDU Length	Displays the MPDU length	(Diff + 1) to 65535 (A-MPDU = Off) (Diff + 1) to 16384 (A-MPDU = On) When Oversampling Ratio = 8, Bandwidth = 20 MHz, MCS = 0, Number of Spatial Streams = 1, A-MPDU = Off: (Diff + 1) to 42500
Total A-MPDU Length	Displays the total A-MPDU Length directly under each User#	1 to 262140 Void when A-MPDU is Off
MAC Frame Type	Sets the type of MAC Frame	Sets the MAC information
MAC Data Type	Sets the data type to be inserted into Mac Frame body	PN9fix, PN15fix, 16bit repeat, User File
Data Type Repeat Data	Sets the 16 bit data to be inserted into Mac Frame body	0x0000 to 0xFFFF (This parameter is displayed only when 16 bit repeat is selected for MAC Data Type)
Data Type User File	Sets the user file to be inserted into Mac Frame body	Any file can be selected (This parameter is displayed only when User File is selected for MAC Data Type)
Frame Control	Sets the frame control	0x0000 to 0xFFFF
Duration/ID	Sets Duration/ID	0x0000 to 0xFFFF
Address1/2/3/4	Sets MAC Address1/2/3/4	0x0000 0000 0000 to 0xFFFF FFFF FFFF
Sequence Control	Sets the Sequence Control	0x0000 to 0xFFFF
QoS Control	Sets the QoS Control	0x0000 to 0xFFFF
HT Control	Sets the HT Control	0x0000 0000 to 0xFFFF FFFF
MAC FCS	Enables/disables the MAC FCS	On, Off
Increment Sequence Number	Enables/disables the Increment of Sequence Number	On, Off If the Increment of Sequence Number sets to On, the count-up operation starts from the upper 12 bits of the value specified for Sequence Control, incrementally at each interval specified by Sequence Number Increment Period
Sequence Number Increment Period	Sets the interval to count up the sequence number	1 to 15 This is available when Increment Sequence Number or Increment Fragment Number is set to On
Increment Fragment Number	Enables/disables the Increment Fragment Number	On, Off If Increment Fragment Number sets to On, the count-up operation starts from the lower 4 bits of the value specified for Sequence Control, incrementally for each packet at each interval specified by Sequence Number Increment Period

MX370112A TD-SCDMA IQproducer



Optional

MG3710A

MX370112A TD-SCDMA IQproducer is PC application software with a GUI for changing parameters and generating waveform patterns in compliance with TD-SCDMA specifications standardized by 3GPP TS 25.221, TS 25.222, TS 25.223, TS 25.105, TS 25.142 (supports TRx tests excluding performance tests).

- **Sub-frame Structure Screen**
Displays RU (Resource Unit) for each channel in different colors. Arranges in cells for 7 slots (for 1 Sub-frame) in RU units.
Horizontal axis: Time Slot, 7RU
Vertical axis: Channel Code, 16RU

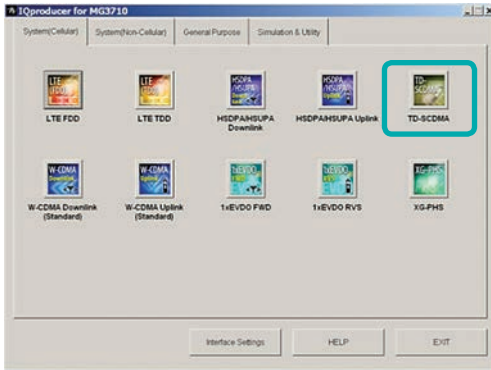

IQproducer Main Screen

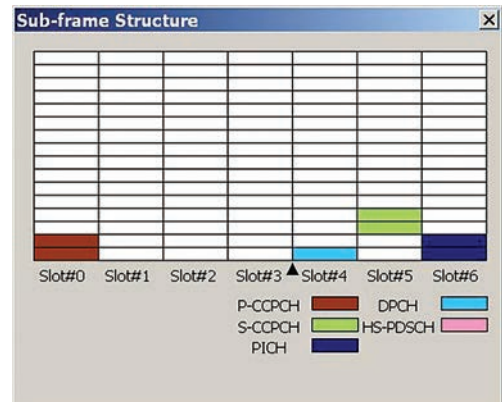
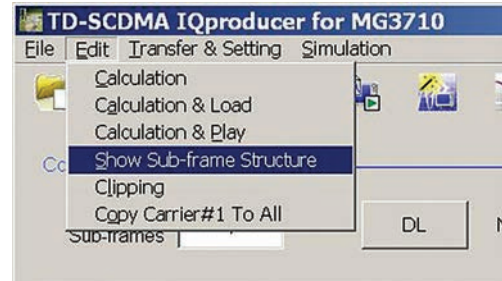

- **TD-SCDMA IQproducer Setting Screen**
Supports both uplink and downlink and settings for up to 6 carriers.

Uplink/Downlink
Link: UL DL

Frequency Offset
Frequency Offset: -4.0, -3.2, -2.4, -1.6, -0.8, 0, +0.8, +1.6, +2.4, +3.2, +4.0

Midamble Config
Default Common UE specification

TD-SCDMA IQproducer Setting Screen
Common Setting: Number of Sub-frames: 1, Link: UL, Number of Carriers: 1, Adjust Carrier Power, Adjust Code Power
Carrier Setting: Carrier#1, Frequency Offset: 0 MHz, Relative Power: 0.00 dB, Channel Coding: ON, Channel Setting, Switching Point: 3, Scrambling Code: 0, Midamble Config: Default
Pattern Setting: Package: TD-SCDMA, Export File Name: TestPattern, Calculation & Load, Calculation & Play

TD-SCDMA IQproducer Setting Screen

MX370112A TD-SCDMA IQproducer

Optional

MG3710A

• Channel Setting Screen

Sets channel parameters for carriers with different channel for uplink and downlink.

For uplink

- UpPCH
- DPCH

For downlink

- P-CCPCH
- S-CCPCH
- DwPCH
- PICH
- DPCH
- HS-PDSCH

Uplink/UpPCH

Channel Setting

UpPCH | DPCH

State: ON

Power: 0.00 dB

Sync-UL code: 0

OK Cancel

Uplink/DPCH

Channel Setting

UpPCH | DPCH

Number of RMC: 1 RMC: 1

State: ON SF: 8

Power: 0.00 dB TFCI: 0

RMC Type: 12.3kps TPC: All

Time Slot: 1 SS: All

Channel Code: 1 Midamble Config: Default

Midamble K: 16

DTCH Data Type: PN9 UE spec shift: 16

DCCH Data Type: PN9 Block Size: 244

DCCH Rate Matching Attribute: 256

OK Cancel

Downlink/P-CCPCH

Channel Setting

P-CCPCH | S-CCPCH | DwPCH | PICH | DPCH | HS-PDSCH

State: ON

Power: 0.00 dB

Data Type: PN9

Midamble Config: Default

Midamble K: 8

UE spec shift: 8

SF: 16

OK Cancel

Downlink/S-CCPCH

Channel Setting

P-CCPCH | S-CCPCH | DwPCH | PICH | DPCH | HS-PDSCH

State: ON TFCI: --

Power: 0.00 dB TPC: --

Time Slot: 0 SS: --

Data Type: PN9 SF: 16

Channel Code: 3 Block Size: --

Slot Format: -- CRC Size: --

Midamble Config: Default Coding Type: --

Midamble K: 8 Rate Matching Attribute: --

UE spec shift: 8

OK Cancel

Downlink/DwPCH

Channel Setting

P-CCPCH | S-CCPCH | DwPCH | PICH | DPCH | HS-PDSCH

State: ON

Power: 0.00 dB

Sync-DL code: 0

OK Cancel

Downlink/PICH

Channel Setting

P-CCPCH | S-CCPCH | DwPCH | PICH | DPCH | HS-PDSCH

State: ON

Power: 0.00 dB

Time Slot: 6

Channel Code: 1

Data Type: PN9

Midamble Config: Default

Midamble K: 16

UE spec shift: 16

SF: 16

OK Cancel

Downlink/DPCH

Channel Setting

P-CCPCH | S-CCPCH | DwPCH | PICH | DPCH | HS-PDSCH

Number of RMC: 1 RMC: 1

State: ON SF: 16

Power: 0.00 dB TFCI: --

RMC Type: -- TPC: --

Time Slot: 4 SS: --

Channel Code: 1 Midamble Config: Default

Midamble K: 16

DTCH Data Type: PN9 UE spec shift: 16

DTCH Rate Matching Attribute: 256 UE spec shift: 16

DCCH Data Type: -- Number of DPCH per TS: 1

DCCH Rate Matching Attribute: 256 Block Size: --

OK Cancel

Downlink/HS-PDSCH

Channel Setting

P-CCPCH | S-CCPCH | DwPCH | PICH | DPCH | HS-PDSCH

HSPA RMC Type: --

State: ON Midamble Config: Default

Power: 0.00 dB Midamble K: 16

Time Slot: 4 UE spec shift: 16

Channel Code: 1 N_JR: --

Slot Format: -- Number of HS-PDSCH per TS: 1

Data Type: PN9 Number of TS: 3

Redundancy Version Parameter: -- SF: 16

HARQ Mode: -- Modulation: QPSK

Block Size: --

OK Cancel

Common Setting

Display	Outline	Setting Range
Number of sub-frames	Sets the number of sub-frames	<Table 1>
Link	Sets DL or UL	UL, DL
Number of Carriers	Sets number of carriers	1 to 6
Adjust Carrier Power	Adjusts Relative Power of each Carrier so that the maximum value of Relative Power is 0.00 dB	
Adjust Code Power	Adjusts each Carrier so that the maximum value of the channel Power is 0.00 dB	

Table 1

Memory Option	Without Memory Option		With Opt. 45/75		With Opt. 46/76	
Combination of Baseband Signal Option	Without Opt. 48/78	With Opt. 48/78	Without Opt. 48/78	With Opt. 48/78	Without Opt. 48/78	With Opt. 48/78
Memory	64 Msamples	64 Msamples × 2	256 Msamples	256 Msamples × 2	1024 Msamples	1024 Msamples × 2
1	2621	5242	10485	20971	20971	20971
2	1310	2621	5242	10485	10485	10485
3 to 6	655	1310	2621	5242	5242	5242

Carrier Setting

Display	Outline	Setting Range
Frequency Offset	Sets carrier frequency offset	-4.0, -3.2, -2.4, -1.6, -0.8, 0, +0.8, +1.6, +2.4, +3.2, +4.0 MHz The frequency offset range of selectable carrier varies according to the setting of Number of Carriers.
Relative Power	Sets the level ratio of selected carrier	0.00 to -40.00 dB, Resolution 0.01 dB
Channel Coding	Enables/disables channel coding	Link = DL: Off Link = UL: On You cannot change the parameter of this function with this version.
Switching Point	Sets a Switching Point position (switching timing between DL and UL)	1 to 6 (This is set after Time Slot with the same value.) When Link is DL, a value beyond Time Slot (later in time) where Channel is already allocated cannot be set to Switching Point. When Link is UL, a value smaller than Time Slot (earlier in time) where Channel is already allocated cannot be set to Switching Point.
Scrambling Code	Sets the scrambling code	0 to 127
Midamble Config	Displays the Midamble Config.	Default, Common, UE Specification

Channel Setting

Display	Outline	Setting Range
When Link is DL		
P-CCPCH		
State	Turns On/Off the channel	On, Off
Power	Sets channel power	0.00 to -40.00 dB, Resolution 0.01 dB
Data Type	Sets the data type to be mapped to channel	PN9, PN15, All0, All1, User File
Midamble Config	Displays the Midamble Config.	The Midamble Config value set in Carrier Setting will be displayed.
Midamble K	Displays the Midamble K value	2, 4, 6, 8, 10, 12, 14, 16
UE spec shift	Sets the UE spec shift value	1 to Midamble K
SF	Displays the spreading factor	Display only
S-CCPCH		
State	Turns On/Off the channel	On, Off
Power	Sets channel power	0.00 to -40.00 dB, Resolution 0.01 dB
Time Slot	Sets the position of Time Slot to be allocated	0, 2 to 6
Data Type	Sets the data type to be mapped to channel	PN9, PN15, All0, All1, User File
Channel Code	Sets the Channelization Code	1 to 15
Midamble Config	Displays the Midamble Config.	The Midamble Config value set in Carrier Setting will be displayed.
Midamble K	Sets the Midamble K value	2, 4, 6, 8, 10, 12, 14, 16
UE spec shift	Sets the UE spec shift value	1 to Midamble K
SF	Displays the spreading factor	Display only
DwPCH		
State	Turns On/Off the channel	On, Off
Power	Sets channel power	0.00 to -40.00 dB, Resolution 0.01 dB
Sync-DL code	Sets the Sync-DL code	It is auto-calculated from the Scrambling Code of Carrier Setting.
PICH		
State	Turns On/Off the channel	On, Off
Power	Sets channel power	0.00 to -40.00 dB, Resolution 0.01 dB
Time Slot	Sets the position of Time Slot to be allocated	0, 2 to 6
Channel Code	Sets the Channelisation Code	1 to 15
Data Type	Sets the data type to be mapped to channel	PN9, PN15, All0, All1, User File
Midamble Config	Displays the Midamble Config.	The Midamble Config value set in Carrier Setting will be displayed.
Midamble K	Sets the Midamble K value	2, 4, 6, 8, 10, 12, 14, 16
UE spec shift	Sets the UE spec shift value	1 to Midamble K
SF	Displays the spreading factor	Display only

MX370112A TD-SCDMA IQproducer

Optional

MG3710A

Display	Outline	Setting Range
DPCH		
Number of RMC	Sets the number of RMC	1 to 8
RMC	Sets the RMC number, which edits detailed parameter	1 to Number of RMC
State	Turns On/Off the channel	On, Off
Power	Sets channel power	0.00 to -40.00 dB, Resolution 0.01 dB
Time Slot	Sets the position of Time Slot to be allocated	0, 2 to 6
Channel Code	Sets the Channelisation Code	1 to SF
DTCH Data Type	Sets the data type to be mapped to channel	PN9, PN15, All0, All1, User File
SF	Sets the spreading factor	1, 16
Midamble Config	Displays the Midamble Config.	The Midamble Config value set in Carrier Setting will be displayed.
Midamble K	Sets the Midamble K value	2, 4, 6, 8, 10, 12, 14, 16
UE spec shift	Sets the UE spec shift value	1 to Midamble K
Number of DPCH per TS	Sets the number of DPCH per each time slot	1 to (SF – Channel Code + 1)
HS-PDSCH		
State	Turns On/Off the channel	On, Off
Power	Sets channel power	0.00 to -40.00 dB, Resolution 0.01 dB
Time Slot	Sets the position of Time Slot to be allocated	0, 2 to 6
Channel Code	Sets the Channelisation Code	1 to SF
Data Type	Sets the data type to be mapped to channel	PN9, PN15, All0, All1, User File
Midamble Config	Displays the Midamble Config.	The Midamble Config value set in Carrier Setting will be displayed.
Midamble K	Sets the Midamble K value	2, 4, 6, 8, 10, 12, 14, 16
UE spec shift	Sets the UE spec shift value	1 to Midamble K
Number of HS-PDSCH per TS	Sets the number of HS-PDSCH per each time slot	1 to SF
Number of TS	Sets the number of time slots that HS-PDSCH uses	1 to (6 – Switching Point)
SF	Sets the spreading factor	1, 16
Modulation	This sets the modulation method of HS-DPCH	QPSK, 16QAM, 64QAM
When Link is UL		
UpPCH		
State	Turns On/Off the channel	On, Off
Power	Sets channel power	0.00 to -40.00 dB, Resolution 0.01 dB
Sync-UL code	Displays the Sync-UL code	floor (Scrambling Code / 4) × 8 to floor (Scrambling Code / 4) × 8 + 7 Where floor(x) is the function for finding the largest integer that does not exceed x.
DPCH		
Number of RMC	Sets the number of RMC	1 to 8
RMC	Sets the RMC number, which edits detailed parameter	1 to Number of RMC
State	Turns On/Off the channel	On, Off
Power	Sets channel power	0.00 to -40.00 dB, Resolution 0.01 dB
RMC Type	Sets the RMC type	12.2 kbps, 64 kbps, 144 kbps, 384 kbps 144 kps is available when the difference of Switching Point – (Time Slot –1) is 2 or more. 384 kps is available when the difference of Switching Point – (Time Slot –1) is 4 or more.
Time Slot	Sets the position of Time Slot to be allocated	1 to 6
Channel Code	Sets the Channelisation Code	1 to SF
DTCH Data Type	Sets the data type to be mapped to DTCH	PN9, PN15, All0, All1, User File
DTCH Rate Matching Attribute	Sets the Rate Matching attribute of DTCH	Display only
DCCH Data Type	Sets the data type to be mapped to DCCH	PN9, PN15, All0, All1, User File
DCCH Rate Matching Attribute	Displays the Rate Matching attribute of DCCH	Display only
SF	Displays the spreading factor	Display only
TFCI	Sets the TFCI (Transport Format Combination Indicator)	0 to 31
TPC	Sets the TPC (Transmitter Power Control)	Repeat 1010, Repeat 0101, All 0, All 1, User File
SS	Sets the synchronization shift parameter	Repeat 1010, Repeat 0101, All 0, All 1, User File
Midamble Config	Displays the Midamble Config.	The Midamble Config value set in Carrier Setting will be displayed.
Midamble K	Sets the Midamble K value	2, 4, 6, 8, 10, 12, 14, 16
UE spec shift	Sets the UE spec shift value	1 to Midamble K
Block Size	Sets the block size of information data	Display only

Ordering Information

Please specify the model/order number, name and quantity when ordering.

The names listed in the chart below are Order Names. The actual name of the item may differ from the Order Name.

Model/Order No.	Name	Remarks
MG3710A	- Main frame - Vector Signal Generator	
MG3710A-032	- Options - (For 1stRF) 1stRF 100 kHz to 2.7 GHz	Select when ordering main frame, select 1stRF frequency range, frequency cannot be changed after installation
MG3710A-034	1stRF 100 kHz to 4 GHz	Select when ordering main frame, select 1stRF frequency range, frequency cannot be changed after installation
MG3710A-036	1stRF 100 kHz to 6 GHz	Select when ordering main frame, select 1stRF frequency range, frequency cannot be changed after installation
MG3710A-062	(For 2ndRF) 2ndRF 100 kHz to 2.7 GHz	Select when ordering main frame, select 2ndRF frequency range, frequency cannot be changed after installation
MG3710A-064	2ndRF 100 kHz to 4 GHz	Select when ordering main frame, select 2ndRF frequency range, frequency cannot be changed after installation
MG3710A-066	2ndRF 100 kHz to 6 GHz	Select when ordering main frame, select 2ndRF frequency range, frequency cannot be changed after installation
MG3740A	- Main frame - Analog Signal Generator	
MG3740A-020	- Options - (Common Parts) Digital Modulation	Adds Digital Modulation function. RF modulation bandwidth: 2 MHz.
MG3740A-032	(For 1stRF) 1stRF 100 kHz to 2.7 GHz	Select when ordering main frame, select 1stRF frequency range, frequency cannot be changed after installation
MG3740A-034	1stRF 100 kHz to 4 GHz	Select when ordering main frame, select 1stRF frequency range, frequency cannot be changed after installation
MG3740A-036	1stRF 100 kHz to 6 GHz	Select when ordering main frame, select 1stRF frequency range, frequency cannot be changed after installation
MG3740A-062	(For 2ndRF) 2ndRF 100 kHz to 2.7 GHz	Select when ordering main frame, select 2ndRF frequency range, frequency cannot be changed after installation
MG3740A-064	2ndRF 100 kHz to 4 GHz	Select when ordering main frame, select 2ndRF frequency range, frequency cannot be changed after installation
MG3740A-066	2ndRF 100 kHz to 6 GHz	Select when ordering main frame, select 2ndRF frequency range, frequency cannot be changed after installation
MX370101A MX370102A MX370103A MX370104A MX370105A MX370106A MX370107A MX370108A MX370108A-001 MX370110A MX370110A-001 MX370111A MX370111A-002 MX370112A	- Softwares - (IQproducer) HSDPA/HSUPA IQproducer TDMA IQproducer CDMA2000 1xEV-DO IQproducer Multi-carrier IQproducer Mobile WiMAX IQproducer DVB-T/H IQproducer Fading IQproducer LTE IQproducer LTE-Advanced FDD Option LTE TDD IQproducer LTE-Advanced TDD Option WLAN IQproducer 802.11ac (160 MHz) Option TD-SCDMA IQproducer	For MG3710A For MG3710A/MG3740 For MG3710A For MG3710A For MG3710A For MG3710A For MG3710A/MG3740 For MG3710A For MG3710A. Requires MX370108A. For MG3710A For MG3710A. Requires MX370110A. For MG3710A For MG3710A. Requires MX370111A. For MG3710A
W3580AE W2496AE W3581AE W2915AE W2916AE W2505AE W2917AE W2918AE W2798AE W2995AE W3023AE W3221AE W3488AE W3582AE	- Optional accessories - MG3710A/MG3740A Operation Manual (Main Unit) MG3710A/MG3740A Operation Manual (IQproducer) MG3710A Operation Manual (Pre-installed Waveform Patterns) MX370101A Operation Manual MX370102A Operation Manual MX370103A Operation Manual MX370104A Operation Manual MX370105A Operation Manual MX370106A Operation Manual MX370107A Operation Manual MX370108A Operation Manual MX370110A Operation Manual MX370111A Operation Manual MX370112A Operation Manual	Booklet, for MG3710A/MG3740A Main Frame (Operation, Remote Control) Booklet, for IQproducer (Operation for Common Parts) Booklet, for Pre-installed Waveform Patterns (Usage, Detailed Parameters) Booklet, for HSDPA/HSUPA IQproducer Booklet, for TDMA IQproducer Booklet, for CDMA2000 1xEV-DO IQproducer Booklet, for Multi-carrier IQproducer Booklet, for Mobile WiMAX IQproducer Booklet, for DVB-T/H IQproducer Booklet, for Fading IQproducer Booklet, for LTE IQproducer/LTE-Advanced FDD Option Booklet, for LTE TDD IQproducer/LTE-Advanced TDD Option Booklet, for WLAN IQproducer/802.11ac Option Booklet, for TD-SCDMA IQproducer

*: For detail, refer to the "MG3710A Product Brochure" or "MG3740A Product Brochure".

Note:

Note:

● **United States**

Anritsu Company

1155 East Collins Blvd., Suite 100, Richardson,
TX 75081, U.S.A.
Toll Free: 1-800-267-4878
Phone: +1-972-644-1777
Fax: +1-972-671-1877

● **Canada**

Anritsu Electronics Ltd.

700 Silver Seven Road, Suite 120, Kanata,
Ontario K2V 1C3, Canada
Phone: +1-613-591-2003
Fax: +1-613-591-1006

● **Brazil**

Anritsu Eletronica Ltda.

Praça Amadeu Amaral, 27 - 1 Andar
01327-010 - Bela Vista - Sao Paulo - SP
Brazil
Phone: +55-11-3283-2511
Fax: +55-11-3288-6940

● **Mexico**

Anritsu Company, S.A. de C.V.

Av. Ejército Nacional No. 579 Piso 9, Col. Granada
11520 México, D.F., México
Phone: +52-55-1101-2370
Fax: +52-55-5254-3147

● **United Kingdom**

Anritsu EMEA Ltd.

200 Capability Green, Luton, Bedfordshire, LU1 3LU, U.K.
Phone: +44-1582-433200
Fax: +44-1582-731303

● **France**

Anritsu S.A.

12 avenue du Québec, Bâtiment Iris 1- Silic 612,
91140 VILLEBON SUR YVETTE, France
Phone: +33-1-60-92-15-50
Fax: +33-1-64-46-10-65

● **Germany**

Anritsu GmbH

Nemetschek Haus, Konrad-Zuse-Platz 1
81829 München, Germany
Phone: +49-89-442308-0
Fax: +49-89-442308-55

● **Italy**

Anritsu S.r.l.

Via Elio Vittorini 129, 00144 Roma, Italy
Phone: +39-6-509-9711
Fax: +39-6-502-2425

● **Sweden**

Anritsu AB

Kistagången 20B, 164 40 KISTA, Sweden
Phone: +46-8-534-707-00
Fax: +46-8-534-707-30

● **Finland**

Anritsu AB

Teknobulevardi 3-5, FI-01530 VANTAA, Finland
Phone: +358-20-741-8100
Fax: +358-20-741-8111

● **Denmark**

Anritsu A/S

Kay Fiskers Plads 9, 2300 Copenhagen S, Denmark
Phone: +45-7211-2200
Fax: +45-7211-2210

● **Russia**

Anritsu EMEA Ltd.

Representation Office in Russia

Tverskaya str. 16/2, bld. 1, 7th floor.
Moscow, 125009, Russia
Phone: +7-495-363-1694
Fax: +7-495-935-8962

● **Spain**

Anritsu EMEA Ltd.

Representation Office in Spain

Edificio Cuzco IV, Po. de la Castellana, 141, Pta. 8
28046, Madrid, Spain
Phone: +34-915-726-761
Fax: +34-915-726-621

● **United Arab Emirates**

Anritsu EMEA Ltd.

Dubai Liaison Office

902, Aurora Tower,
P O Box: 500311- Dubai Internet City
Dubai, United Arab Emirates
Phone: +971-4-3758479
Fax: +971-4-4249036

● **India**

Anritsu India Private Limited

2nd & 3rd Floor, #837/1, Binnamangla 1st Stage,
Indiranagar, 100ft Road, Bangalore - 560038, India
Phone: +91-80-4058-1300
Fax: +91-80-4058-1301

● **Singapore**

Anritsu Pte. Ltd.

11 Chang Charn Road, #04-01, Shriro House
Singapore 159640
Phone: +65-6282-2400
Fax: +65-6282-2533

● **P.R. China (Shanghai)**

Anritsu (China) Co., Ltd.

Room 2701-2705, Tower A,
New Caohejing International Business Center
No. 391 Gui Ping Road Shanghai, 200233, P.R. China
Phone: +86-21-6237-0898
Fax: +86-21-6237-0899

● **P.R. China (Hong Kong)**

Anritsu Company Ltd.

Unit 1006-7, 10/F., Greenfield Tower, Concordia Plaza,
No. 1 Science Museum Road, Tsim Sha Tsui East,
Kowloon, Hong Kong, P.R. China
Phone: +852-2301-4980
Fax: +852-2301-3545

● **Japan**

Anritsu Corporation

8-5, Tamura-cho, Atsugi-shi, Kanagawa, 243-0016 Japan
Phone: +81-46-296-6509
Fax: +81-46-225-8359

● **Korea**

Anritsu Corporation, Ltd.

5FL, 235 Pangyoyeok-ro, Bundang-gu, Seongnam-si,
Gyeonggi-do, 13494 Korea
Phone: +82-31-696-7750
Fax: +82-31-696-7751

● **Australia**

Anritsu Pty. Ltd.

Unit 20, 21-35 Ricketts Road,
Mount Waverley, Victoria 3149, Australia
Phone: +61-3-9558-8177
Fax: +61-3-9558-8255

● **Taiwan**

Anritsu Company Inc.

7F, No. 316, Sec. 1, NeiHu Rd., Taipei 114, Taiwan
Phone: +886-2-8751-1816
Fax: +886-2-8751-1817

Please Contact: